



PelcoNet™ NET350 Multimedia Transmission Via Network



C2907M-D (4/05)

Contents

Important Safeguards and Warnings	7
Regulatory Notices	7
Radio and Television Interference	7
What Is the PelcoNet NET350 Transmission System?	8
How Do LANs and WANs Work?	8
Who Should Install the PelcoNet NET350 Transmission System?	8
Instructions for the Network Administrator	9
The Transmitter and Receiver	9
The Browser	9
Minimum PC Requirements (As Needed)	9
Overview	10
Description	10
Software Version	10
Package Contents	10
Optional Compatible Products	10
Front Panel Components	11
Rear Panel Components	11
Typical Applications	12
Hardware Installation	23
Mounting the NET350 to the Wall	23
Connecting Video Sources or Displays	23
Connecting Data Terminals	24
Pin Assignments	24
Connecting Audio Equipment	24
Connecting an Alarm	25
Connecting a Relay	26
Connecting to a LAN	26
Switching on Power	26
Configuration	27
Box-to-box Connection	27
Configuration Types	27
Configuration Using a Web Browser	27
Getting Started	28
Setup Page	30
Configuration Page for General Settings	31
Configuration Page for MPEG-4 Video Settings	33
Configuration Page for Video Decoder Settings (Receiver Only)	35
Configuration Page for Audio Settings	36
Configuration Page for Alarm Settings	37
Configuration Page for Relay Settings	41
Configuration Page for COM 1 Interface Settings	42
Configuration Page for COM 2 Interface Settings	43
Configuration Page for Local COM Interface – Keyboard	44
Configuration Page for Network Settings	45
Configuration Pages for Media Recording	46
Configuration Using a Terminal Program	50
Typical Session	51
Terminal Program Transmitter Menu Structure	52
Terminal Program Receiver Menu Structure	53
Command Reference	54
Operation	55
Live Video and Server Push Video Pages	55
Displaying Video On a Web Browser	56

Using the Audio Transmission Feature of a Live Video Page	57
Web Browser Control Pages	57
Matrix Live Video/Server Push Page Contents	58
Genex Live Video/Server Push Page Contents	59
Spectra Live Video/Server Push Page Contents	60
Esprit Live Video/Server Push Page Contents	61
Keyboard Live Video/Server Push Page Contents	63
Recording and Viewing the Display on a PC and the NET350	63
Choosing Where to Store the File	63
Recording a Snapshot from Video	64
Viewing a Snapshot	64
Recording the Video Display onto the PC	64
Recording the Video Display Through Compactflash	64
Viewing the Video Display	65
Media Playback Screen	66
Viewing a File	66
Backing up a File Onto a Computer	67
Recording a Snapshot from a File	67
Software Upload	68
Resetting the NET350	68
Troubleshooting	69
LEDs	69
Terminal Program	69
Troubleshooting a TCP/IP Network Using a Ping Utility	69
Troubleshooting Connection Problems	70
Troubleshooting the Video Connection	70
Specifications	71
Glossary	72
Appendix A — Connecting PelcoNet to Various Components	74
Connecting PelcoNet to Various Components with Assorted Keyboards	75
Connection Scenario 1 — Using a KBD300A In Direct Mode	75
Connection Scenario 2 — Using a KBD4000 for Multiplexer Control	76
Connection Scenario 3 — Using a CM9760-KBD	77
Connecting a Local Keyboard to a PC	78
Connecting PelcoNet COM 1 RS-232 Port to the Genex Multiplexer COM Out Port	78
Connecting PelcoNet to a CM6700 and KBD200A for Remote ASCII Control	79
Connecting PelcoNet to a CM6700 ASCII Port	80
Connecting PelcoNet to a CM9760-DT for Remote Browser Control	81
Connecting PelcoNet to CM9700 for Remote Communication	82
Connecting a PelcoNet Transmitter to the CM6800 ASCII Port	84
Connecting PelcoNet to a CM6800 and KBD200A for Remote Control	85
Appendix B — Frequently Asked Questions (FAQs)	86
Index	88

List of Illustrations

1	Front Panel Components	11
2	Rear Panel Components	11
3	Configuration for Box-To-Box Connections	12
4	LAN Box-To-Box Connection (Transmitter, Receiver, Fixed Camera)	13
5	LAN Box-To-Box Connection (Transmitter, Receiver, Spectra)	14
6	LAN Box-To-Box Connection (Transmitter, Receiver, Spectra, Genex)	15
7	LAN Browser-To-Box Connection (Transmitter, Browser, Fixed Camera)	16
8	LAN Browser-To-Box Connection (Transmitter, Browser, Spectra)	16
9	LAN Browser-To-Box Connection (Transmitter, Browser, Spectra, Genex)	17
10	WAN Box-To-Box Connection (Transmitter, Receiver, Fixed Camera)	18
11	WAN Box-To-Box Connection (Transmitter, Receiver, Spectra)	19
12	WAN Box-To-Box Connection (Transmitter, Receiver, Spectra, Genex)	20
13	WAN Browser-To-Box Connection (Transmitter, Browser, Fixed Camera)	21
14	WAN Browser-To-Box Connection (Transmitter, Browser, Spectra)	21
15	WAN Browser-To-Box Connection (Transmitter, Browser, Spectra, Genex)	22
16	Connection with Pelco Keyboard Control Through a PC (Example Shown with Spectra and Genex)	22
17	Securing NET350 to Wall Mount Bracket	23
18	Connecting Audio Equipment	24
19	Alarm and Relay Connections	25
20	Connecting to the LAN Port	26
21	PelcoNet Home Page	28
22	PelcoNet NET350 Menu Tree	29
23	PelcoNet NET350 Setup Page	30
24	Configuration Page for General Settings	31
25	Configuration Page for MPEG-4 Video Settings (Only One Example Shown)	33
26	Configuration Page for Video Decoder Settings (Receiver Only)	35
27	Configuration Page for Audio Settings	36
28	Configuration Page for Alarm Settings	37
29	Motion Detection Screen	37
30	Motion Detection Grid Screen	38
31	Configuration Page for Relay Settings	41
32	Configuration Page for COM 1 Interface Settings	42
33	Configuration Page for COM 2 Interface Settings	43
34	Configuration Page for Local Com Interface – Keyboard	44
35	Configuration Page for Network Settings	45
36	Partition Settings Page	47
37	Configuration Page for Time Recording Settings	47
38	Configuration Page for Alarm Recording Settings	48
39	Configuration Page for Properties Settings	49
40	Live Video and Server Push Video Pages	55
41	PelcoNet NET350 Home Page	56
42	Device Controls Page	57
43	Matrix Control Page (Live Video Page Shown)	58
44	Genex Control Page (Live Video Page Shown)	59
45	Spectra Control Page (Live Video Page Shown)	60
46	Esprit Control Page (Live Video Page Shown)	61
47	Keyboard Control Page (Live Video Page Shown)	63
48	Viewer Screen	65
49	Media Playback Screen	66
50	DB9 Cable Wire Splicing	74
51	KBD300A (Direct Mode) Connected to a Receiver or Spectra Dome System	75
52	KBD4000 Connected to a Multiplexer	76
53	CM9760-KBD Connected to a CM9700-CC1 Controller	77
54	Connecting a Local Keyboard to a PC	78
55	Connecting PelcoNet to Genex Using the COM 1 RS-232 Port	78
56	Using PelcoNet with CM6700 and KBD200A to Provide Remote Control	79
57	Using PelcoNet with CM6700 to Provide Remote Control	80
58	Using PelcoNet with CM9760-DT to Provide Remote Control of a 9760 Monitor Output	81
59	Using PelcoNet to Transmit Data and Video Between 9700 Nodes (9760 Shown)	82

60	Using PelcoNet to Receive Data and Video Between 9700 Nodes (9760 Shown)	.83
61	Manager Screen	.84
62	Menu Screen	84
63	Using PelcoNet with CM6800 and KBD200A to Provide Remote Control	.85

List of Tables

A	Pin Assignments	24
B	Terminal Command Reference	54
C	Live Video Page Indicators	55
D	LED Definitions	69

Important Safeguards and Warnings

Observe the following warnings before installing and using this product.

1. Read these instructions.
2. Keep these instructions.
3. Heed all warnings.
4. Follow all instructions.
5. Do not use this apparatus near water.
6. Clean only with dry cloth.
7. Do not block any ventilation openings. Install in accordance with the manufacturer's instructions.
8. Do not install near any heat sources such as radiators, heat registers, stoves, or other apparatus (including amplifiers) that produce heat.
9. Only use attachments/accessories specified by the manufacturer.
10. Refer all servicing to qualified service personnel. Servicing is required when the apparatus has been damaged in any way, such as when the power supply cord or plug is damaged, liquid has been spilled or objects have fallen into the apparatus, the apparatus has been exposed to rain or moisture, the apparatus does not operate normally, or the apparatus has been dropped.
11. Apparatus shall not be exposed to dripping or splashing, and no objects filled with liquids, such as vases, shall be placed on the apparatus.
12. **Warning:** To reduce the risk of fire or electric shock, do not expose this apparatus to rain or moisture.
13. To reduce the risk of shock, do not perform any servicing other than that contained in the operating instructions unless you are qualified to do so.
14. Unless the unit meets NEMA Type 3, 3R, 3S, 4, 4X, 6, or 6P standards, it is designed for indoor use only and must not be installed where exposed to rain and moisture.
15. Only use parts recommended by Pelco.
16. Use only installation methods and materials capable of supporting four times the maximum specified load.

REGULATORY NOTICES

This device complies with part 15 of the FCC Rules. Operation is subject to the following two conditions: (1) this device may not cause harmful interference, and (2) this device must accept any interference received, including interference that may cause undesired operation.

RADIO AND TELEVISION INTERFERENCE

This equipment has been tested and found to comply with the limits of a Class B digital device, pursuant to part 15 of the FCC rules. These limits are designed to provide reasonable protection against harmful interference in a residential installation. This equipment generates, uses, and can radiate radio frequency energy and, if not installed and used in accordance with the instructions, may cause harmful interference to radio communications. However there is no guarantee that the interference will not occur in a particular installation. If this equipment does cause harmful interference to radio or television reception, which can be determined by turning the equipment off and on, the user is encouraged to try to correct the interference by one or more of the following measures:

- Reorient or relocate the receiving antenna.
- Increase the separation between the equipment and the receiver.
- Connect the equipment into an outlet on a circuit different from that to which the receiver is connected.
- Consult the dealer or an experienced radio/TV technician for help.

You may also find helpful the following booklet, prepared by the FCC: "How to Identify and Resolve Radio-TV

Interference Problems." This booklet is available from the U.S. Government Printing Office, Washington D.C. 20402.

Changes and modifications not expressly approved by the manufacturer or registrant of this equipment can void your authority to operate this equipment under Federal Communications Commission's rules.

What Is the PelcoNet NET350 Transmission System?

The PelcoNet™ NET350 transmission system is technology that lets you view video in real time across a LAN (local area network) and even WANs (wide area networks). This technology is based on the TCP/IP protocol suite and Ethernet technology, providing compatibility with today's networking standards.

The following devices can be controlled from your computer through Internet Explorer with the PelcoNet NET350 transmission system: Spectra®, Esprit®, Genex® multiplexer, CM9700 systems (older CM9760s require CM9760 data translator), CM6700 (through integrated ASCII port, COM 2), and the CM6800 matrix.

(Refer to *Glossary* section for definitions of terms used in this manual.)

HOW DO LANS AND WANS WORK?

- A LAN consists of multiple computers connected together, sharing information. This information could be files, e-mail, printers, or with the PelcoNet NET350 transmission system even live video and audio.
- A WAN consists of multiple LANs connected through routers and gateways (for example, the Internet).
- In any network environment, each device needs a unique address so other computers on the network know how to reach it.

It is similar to a city with street addresses. For the post office to deliver mail to your house, you need a unique street address for the mail carrier to find you. A network is like a city. Like a street address, the IP address on your computer is your address on the network. The IP address is how other computers can find you on the network.

Remember that the **IP address must be unique on the network.**

- When there are multiple networks and you are using the TCP/IP protocol, there must be a way to communicate between the two networks. A physical device called a router is required. The router's IP address is referred to as the default gateway IP address.
- A cable that connects one computer to another is like a city street you can use to get from one house to another. The cable lets you communicate with each other on the network. This cable is Category 5 cable with RJ-45 connectors at each end. (It looks like a phone cord, only slightly larger.)

WHO SHOULD INSTALL THE PELCONET NET350 TRANSMISSION SYSTEM?

NOTE: Unless you are very familiar with how computers work, consult your network administrator for help.

Installation is a matter of configuring an IP address using a standard terminal program or Internet Explorer and connecting the PelcoNet NET350 transmission system to the Ethernet network. You should have the following background and experience to configure and install these units:

- Working knowledge of basic network management concepts and terminology
- Working knowledge of tools and procedures for installing and operating sensitive electronic equipment

Instructions for the Network Administrator

The PelcoNet NET350 transmission system allows live video transmission to be viewed over TCP/IP-based networks. This section is intended to help the network administrator know what is involved with installing this product and how it will affect the network. The person installing the product will need the following information about the network to make the network function properly.

THE TRANSMITTER AND RECEIVER

- A valid IP address* for each PelcoNet NET350 transmission system unit
- Subnet mask*
- Default gateway (if applicable)
- E-mail server's IP address (if applicable)
- Dedicated maximum allowable amount of bandwidth for live video**

* = Required for the PelcoNet NET350 transmission system to function properly

** = The PelcoNet NET350 transmission system requires a continuous amount of bandwidth to display true live video. Pelco recommends using switching hubs with the product so the amount of bandwidth available to each unit is constant and reliable.

THE BROWSER

If you plan to use a browser to view live video across the network, there are procedures to complete before you can use the browser, such as installing the ActiveX® platform. If you installed Internet Explorer 6.0 from the CD that came with the PelcoNet NET350 transmission system, you can skip step 1 below. Otherwise, perform the following before trying to use the browser.

1. Internet Explorer 6.0 or higher must be installed before continuing.
2. Set the computer's display settings to use 16- or 32-bit color.
3. Insert the supplied resource CD. It will open automatically. **If it fails to open automatically**, perform steps a through d below.
 - a. Click the **Start** menu in the Windows® operating system.
 - b. Click **Run**.
 - c. In the Open box, type **D:\START.EXE** (where D:\ = your CD ROM drive letter).
 - d. Click **OK**.
4. Click **Software** and then click **Install PelcoNet ActiveX**.
5. Follow the on-screen setup instructions to finish installing the plug-in.

MINIMUM PC REQUIREMENTS (AS NEEDED)

- PC (Pentium® 4 microprocessor, 1.6 GHz) with Windows 98/2000/XP operating system
- Network card
- Microsoft® Internet Explorer 6.0 (or higher) or PelcoNet NET350R (receiver) and video monitor
- Free serial interface and terminal program
- Screen resolution of 1024 x 768 or higher, 16- or 32-bit pixel color resolution
- RAM of 256 MB
- Graphic card (ATI RADEON 7500 or 8500, Matrox G 550 or Parhelia™, or NVIDIA® GeForce 3 or 4 with direct show-compatible MPEG-4 playback capability)
- Ethernet card (100 Mbit recommended)
- Sound card (required for audio application)
- DirectX® 8.1 or 9.0 application programming interface software

Overview

NOTE: This manual refers to the PelcoNet NET350 transmission system unit when discussing features, functions, or specifications that apply to both transmitter and receiver models. "Receiver," as used in this manual, refers to a PelcoNet NET350 transmission system receiver unless otherwise noted.

DESCRIPTION

The PelcoNet NET350 transmission system is a network video server that encodes and decodes live video, audio, and control data transmitted and received over Ethernet computer networks (either intranet or Internet) using the TCP/IP protocol.

The transmission system consists of two units: a transmitter (NET350T) and a receiver (NET350R) however, only the transmitter is required to use the system. If a receiver is used, video can be displayed on an NTSC or PAL monitor connected to the receiver. If a receiver is not used, video can be displayed on a PC connected to the network through a web browser.

The NET350T includes a CompactFlash® interface for video storage.

Dual MPEG-4 video streams, each of which can be set up differently, is a special feature of the NET350. For example, one video stream might be set to record at high resolution while the second might have monitoring at a lower resolution.

Transmitters and receivers are identified by IP addresses, just like any other equipment connected to a computer network.

There is a bidirectional serial interface for remote control of peripherals, such as PTZ cameras. The NET350T can transmit and receive audio and the NET350R can receive audio.

In appropriately configured networks, the multicast function permits simultaneous video transmission in real time to several receivers. For this to work, the UDP and IGMP multicasting protocols must be implemented in the network.

SOFTWARE VERSION

This manual documents PelcoNet NET350 software version 3.0.

PACKAGE CONTENTS

The following are supplied:

- Transmitter (NET350T) or receiver (NET350R)
- Universal plug-in power pack with adapters for EU, UK, US, and AU
- DB9 cable with pigtail
- Wall mount bracket
- Quick installation guide
- Software resource CD

OPTIONAL COMPATIBLE PRODUCTS

NET350RK The NET350RK rack mount kit provides rack mounting for the PelcoNet NET350. This kit supports the mounting of one, two, or three units per rack. Units can be mounted with either front or rear panel forward.

FRONT PANEL COMPONENTS

The PelcoNet NET350 transmission system uses a compact design. For that reason connectors are placed on both the front and rear panels.

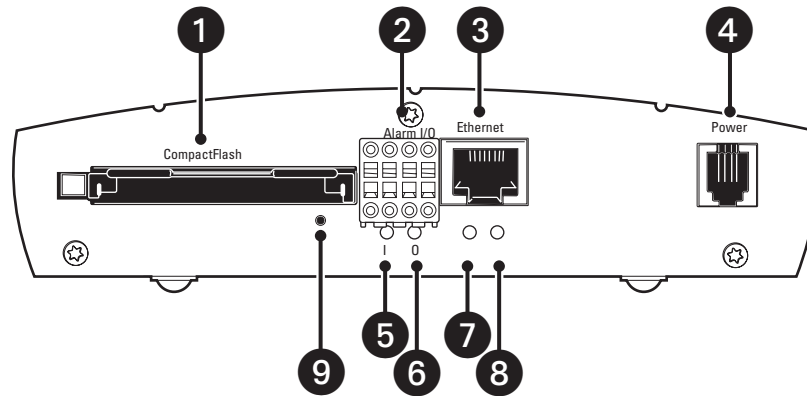

Key:

- 1 = **CompactFlash** interface (transmitter only) is a slot for CompactFlash cards and miniature disk drives
- 2 = **Alarm I/O** terminals for alarm input and relay output (refer to Figure 19)
- 3 = RJ-45 **Ethernet** connector for connecting to the network (10/100)
- 4 = **Power** socket
- 5 = LED **I** lights red with an active alarm
- 6 = LED **O** lights green when the relay is switched
- 7 = LED **L** lights green when the unit is connected to the network
- 8 = LED **T** flashes yellow when data is transmitted
- 9 = **Hard reset** button

Figure 1. Front Panel Components

(Refer to the *LEDs* section for more information on the LEDs.)

REAR PANEL COMPONENTS

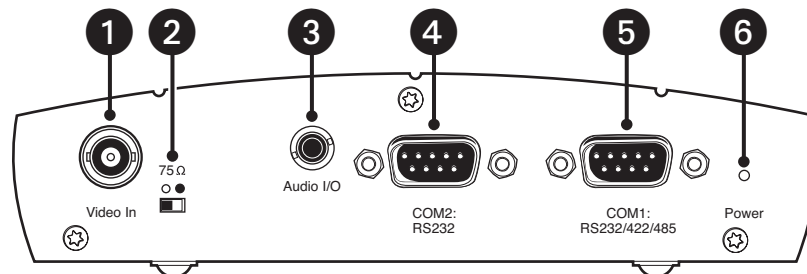

Key:

- 1 = **Video In** BNC socket (transmitter) or **Video Out** BNC socket (receiver) for video source or for an analog video monitor
- 2 = **75 Ω** slide switch (transmitter) for terminating the video input
- 3 = **Audio I/O** bidirectional audio interface; 3.5 mm stereo jack for connecting a loudspeaker or an audio source (monaural line), line level
- 4 = **COM2: RS232** serial interface port; 9-pin male sub-D socket for configuration using terminal software
- 5 = **COM1: RS232/422/485** serial interface port; 9-pin male sub-D socket for controlling data transmissions (RS-232, RS-422, and RS-485 protocols) and for configuration using terminal software
- 6 = Power LED for device status and software upload failure (refer to the *LEDs* section)

Figure 2. Rear Panel Components

Refer to the *LEDs* section for more information on the LEDs and to the *Hardware Installation* section for information on interfacing peripherals to the unit.

Typical Applications

There are two ways to make a high performance multimedia transmission system for computer networks:

- One way is to use just the transmitter and connect it through the computer network to a PC with a web browser at the receiving end.
- Another way is to connect the transmitter through the computer network to a receiver. This is often called a box-to-box connection because it uses two PelcoNet NET350 transmission system units.

In either case, routing dedicated cables from a camera to a monitor is not required because you can use the existing computer network for that purpose.

Refer to figures 3 through 16 for examples of these configurations. Refer to *Appendix A* for detailed connection illustrations.

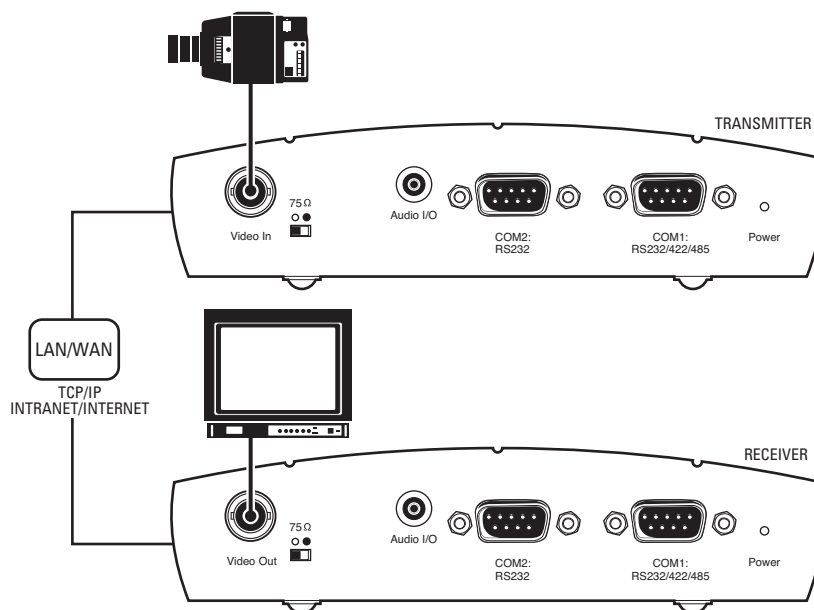

Figure 3. Configuration for Box-To-Box Connections

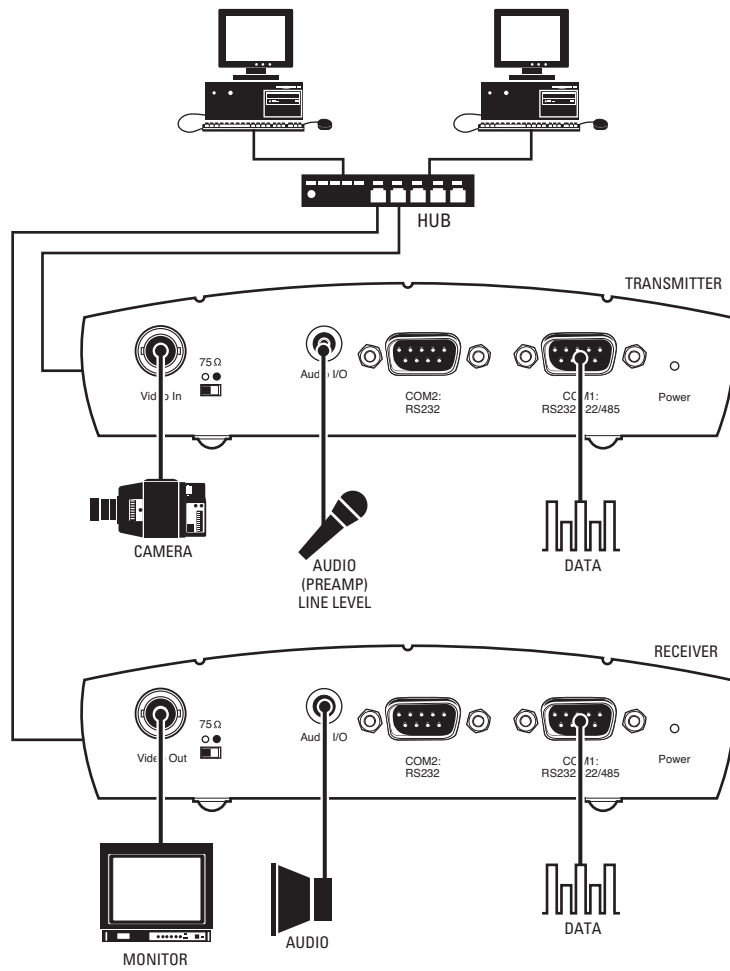

Figure 4. LAN Box-To-Box Connection (Transmitter, Receiver, Fixed Camera)

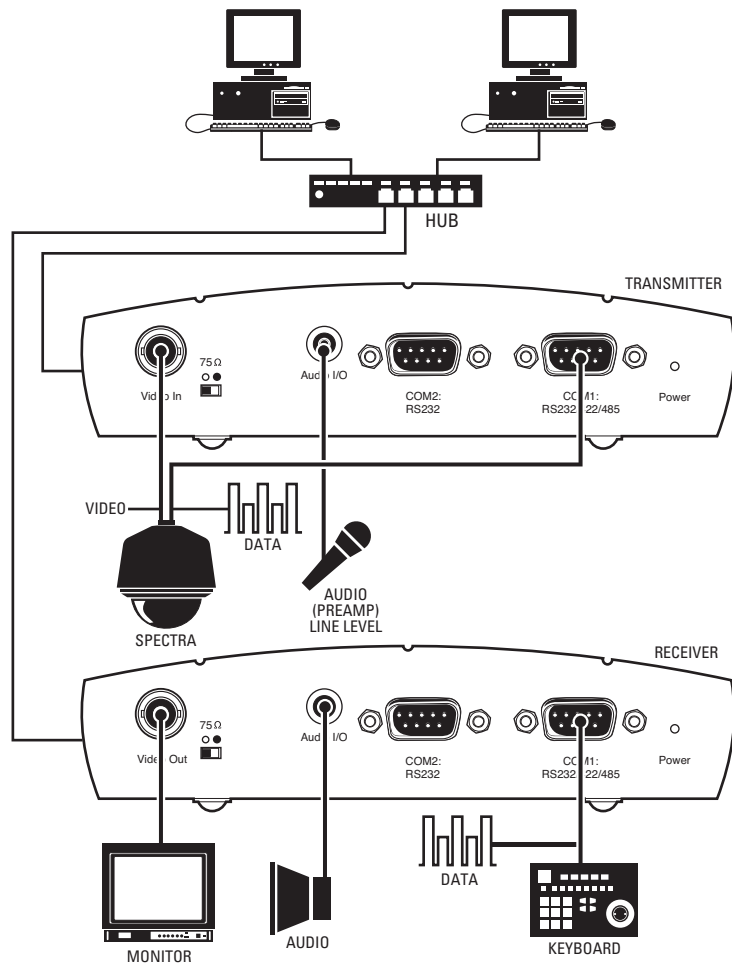

Figure 5. LAN Box-To-Box Connection (Transmitter, Receiver, Spectra)

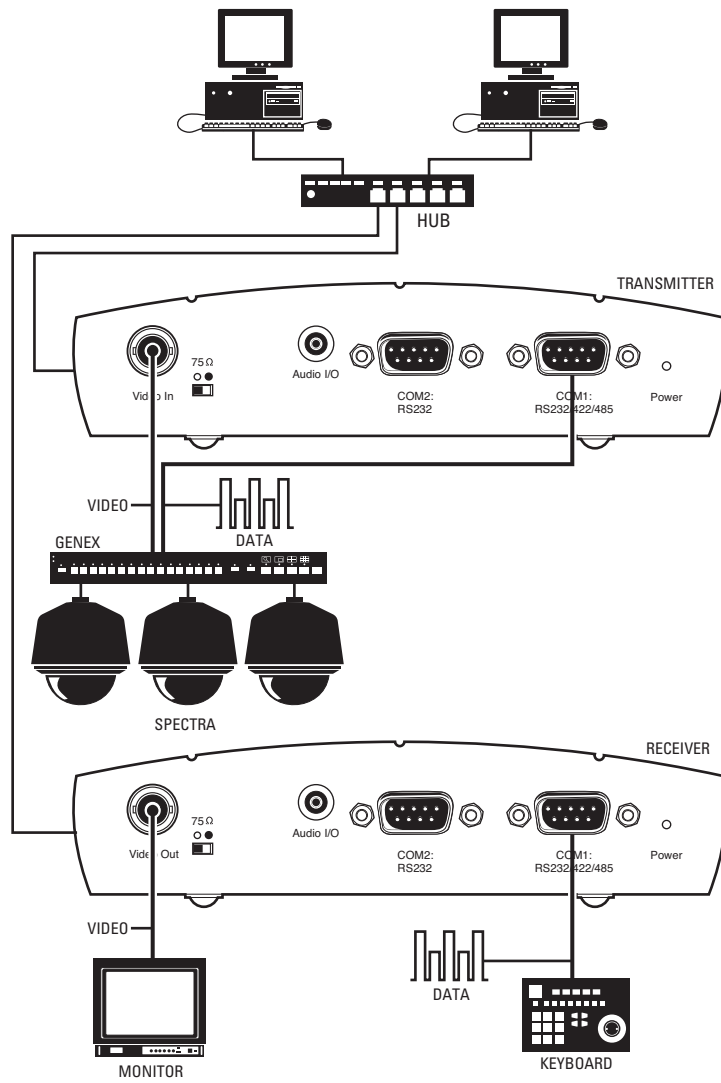

Figure 6. LAN Box-To-Box Connection (Transmitter, Receiver, Spectra, Genex)

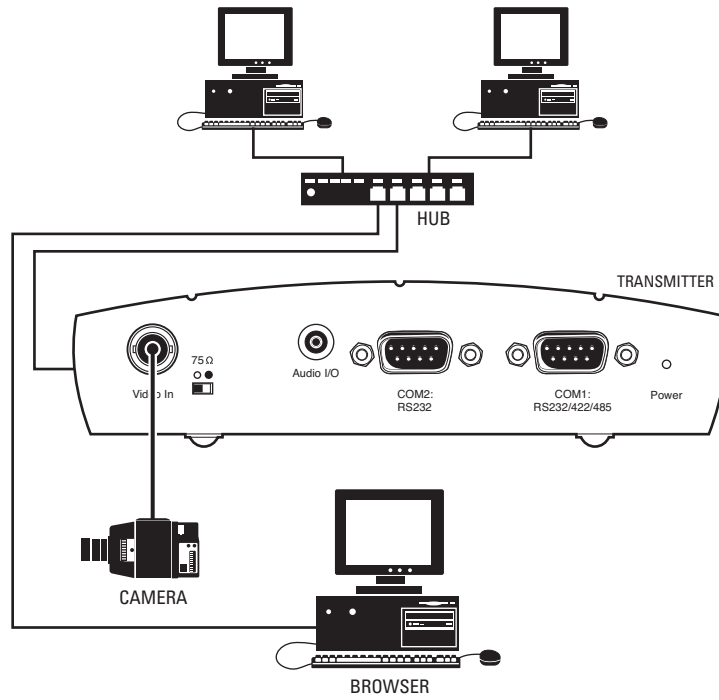

Figure 7. LAN Browser-To-Box Connection (Transmitter, Browser, Fixed Camera)

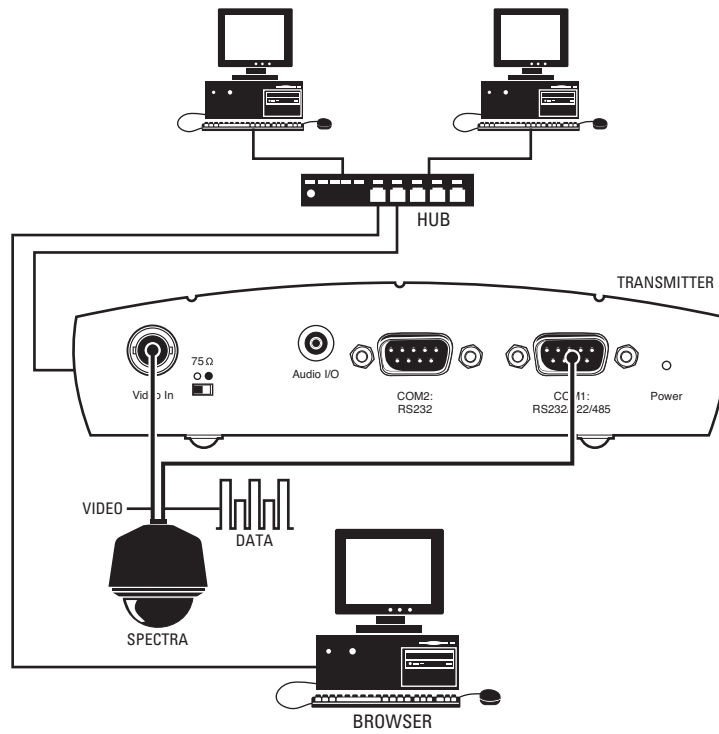

Figure 8. LAN Browser-To-Box Connection (Transmitter, Browser, Spectra)

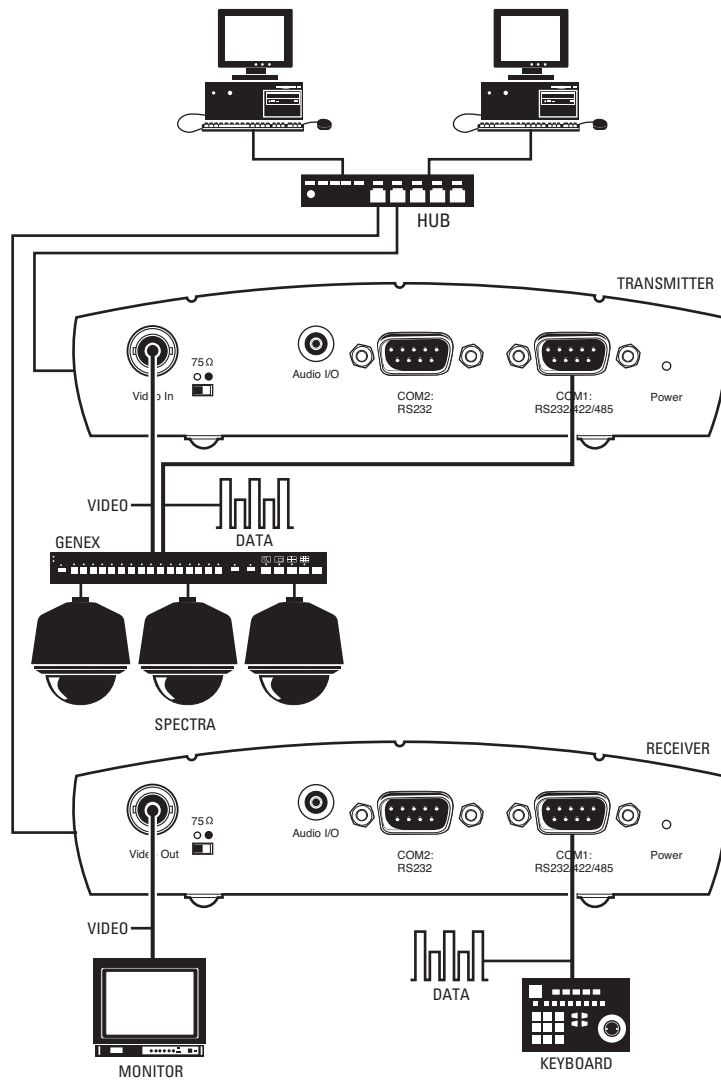

Figure 9. LAN Browser-To-Box Connection (Transmitter, Browser, Spectra, Genex)

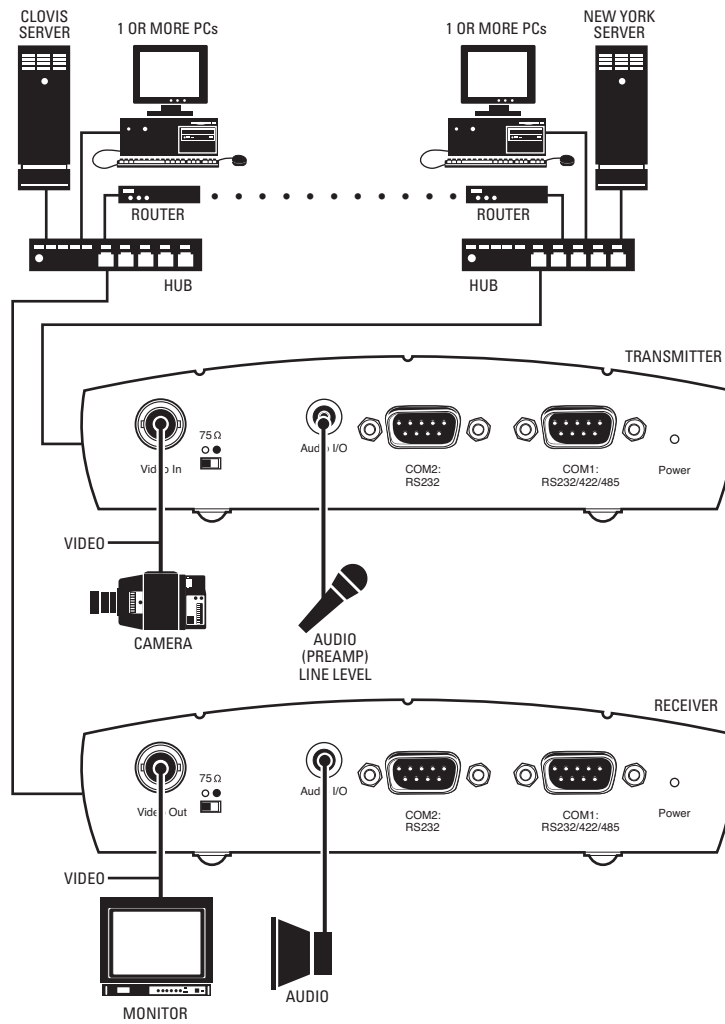

Figure 10. WAN Box-To-Box Connection (Transmitter, Receiver, Fixed Camera)

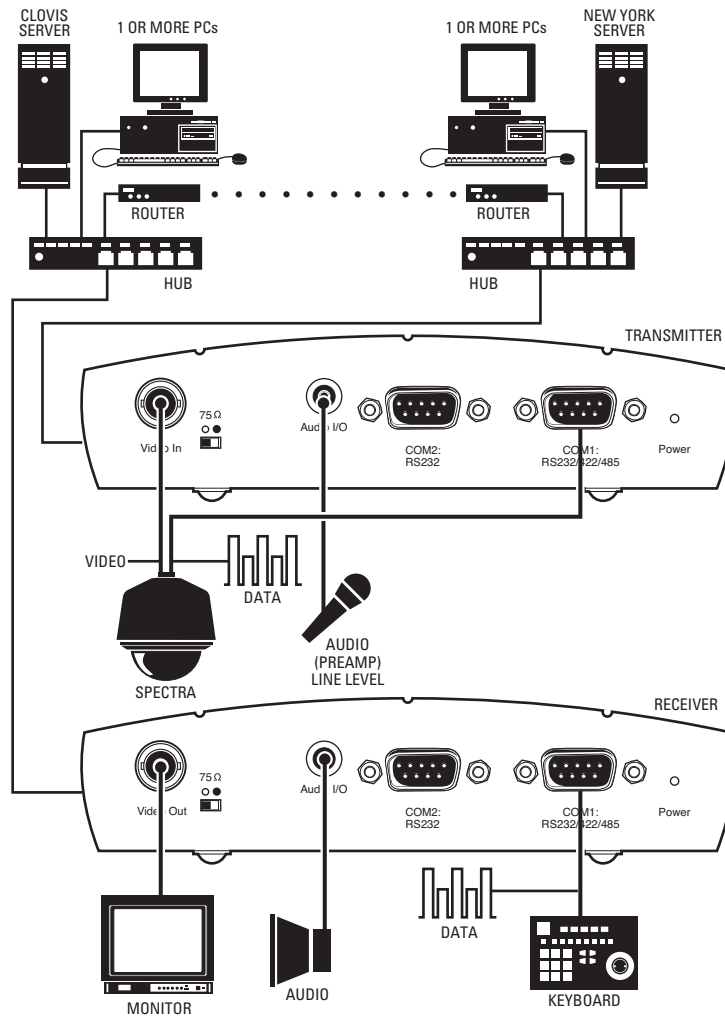

Figure 11. WAN Box-To-Box Connection (Transmitter, Receiver, Spectra)

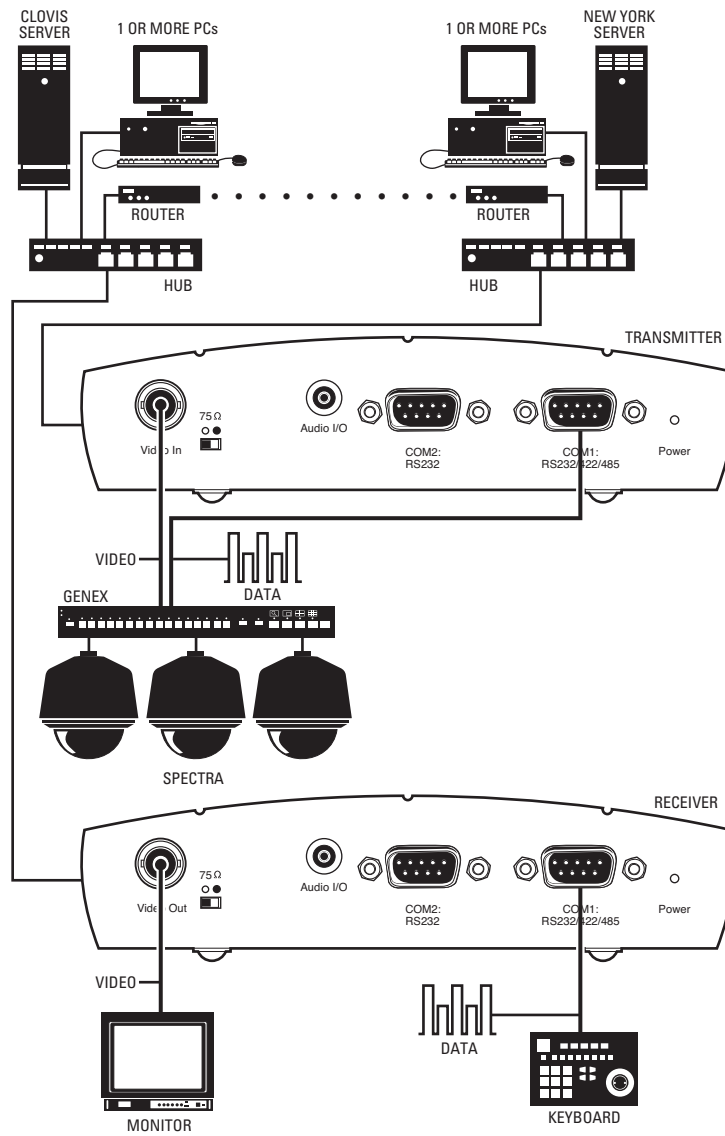

Figure 12. WAN Box-To-Box Connection (Transmitter, Receiver, Spectra, Genex)

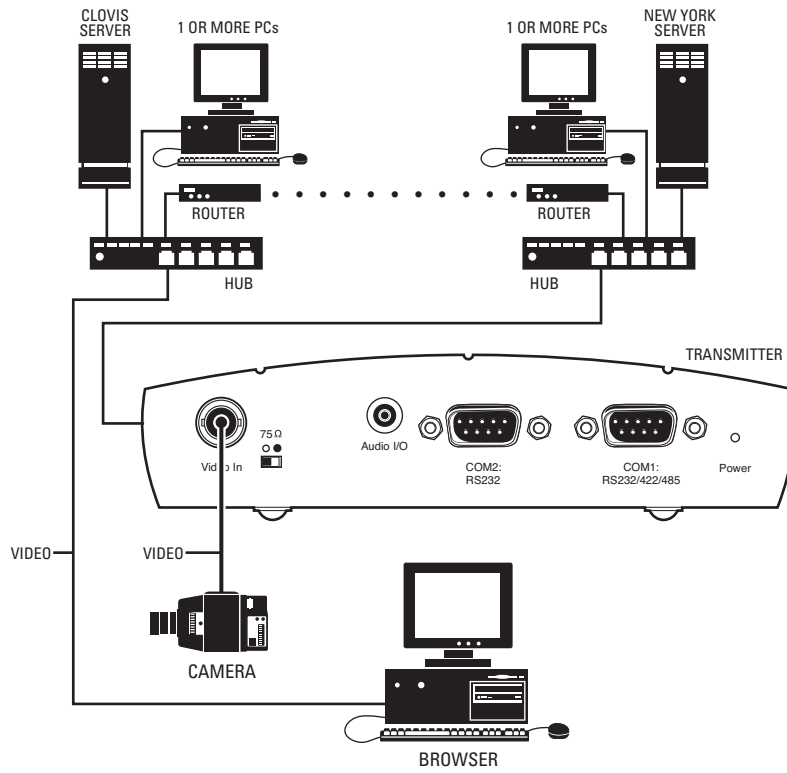

Figure 13. WAN Browser-To-Box Connection (Transmitter, Browser, Fixed Camera)

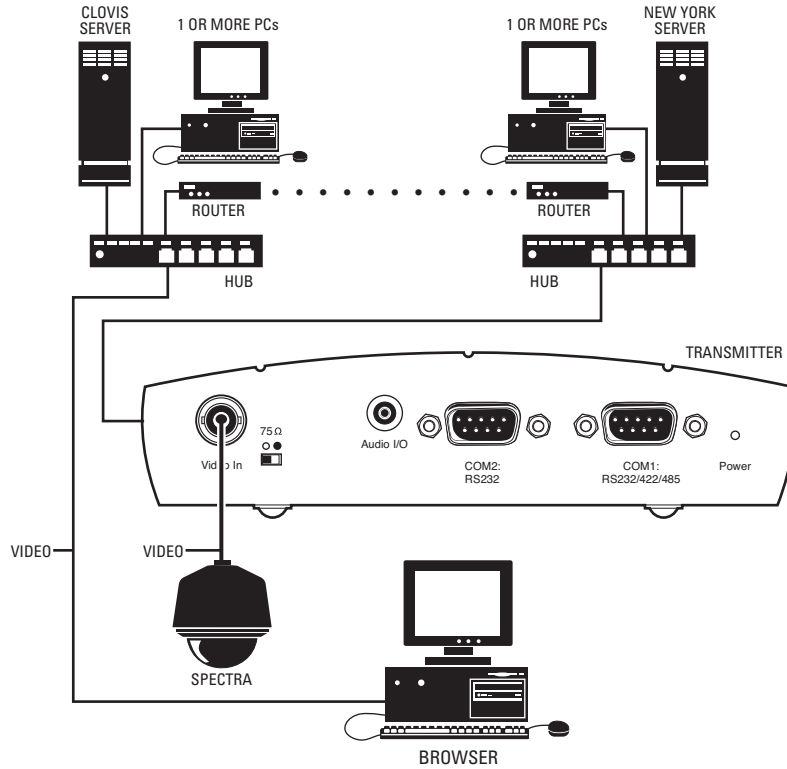

Figure 14. WAN Browser-To-Box Connection (Transmitter, Browser, Spectra)

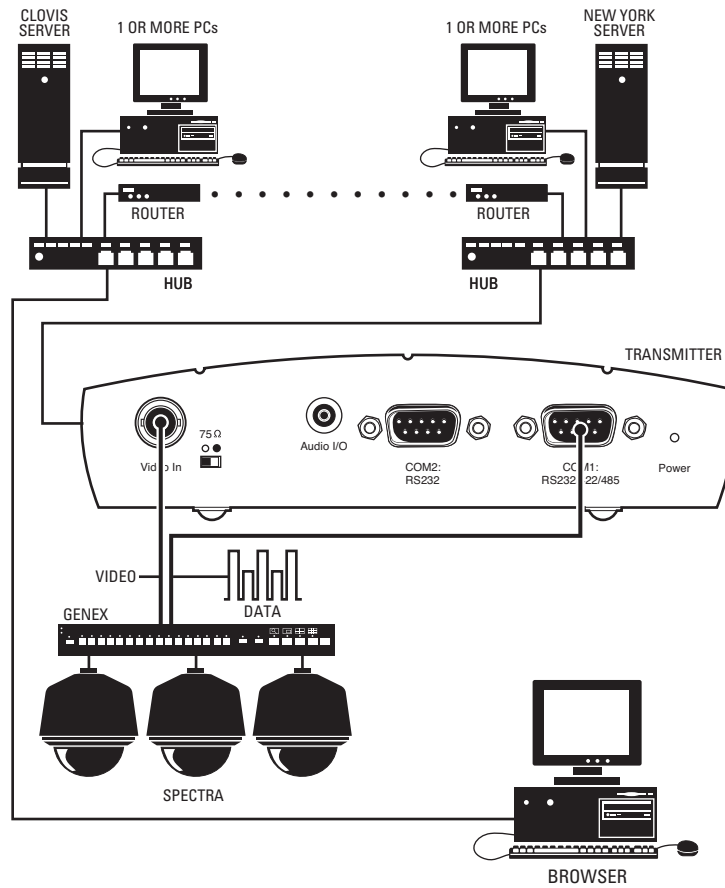

Figure 15. WAN Browser-To-Box Connection (Transmitter, Browser, Spectra, Genex)

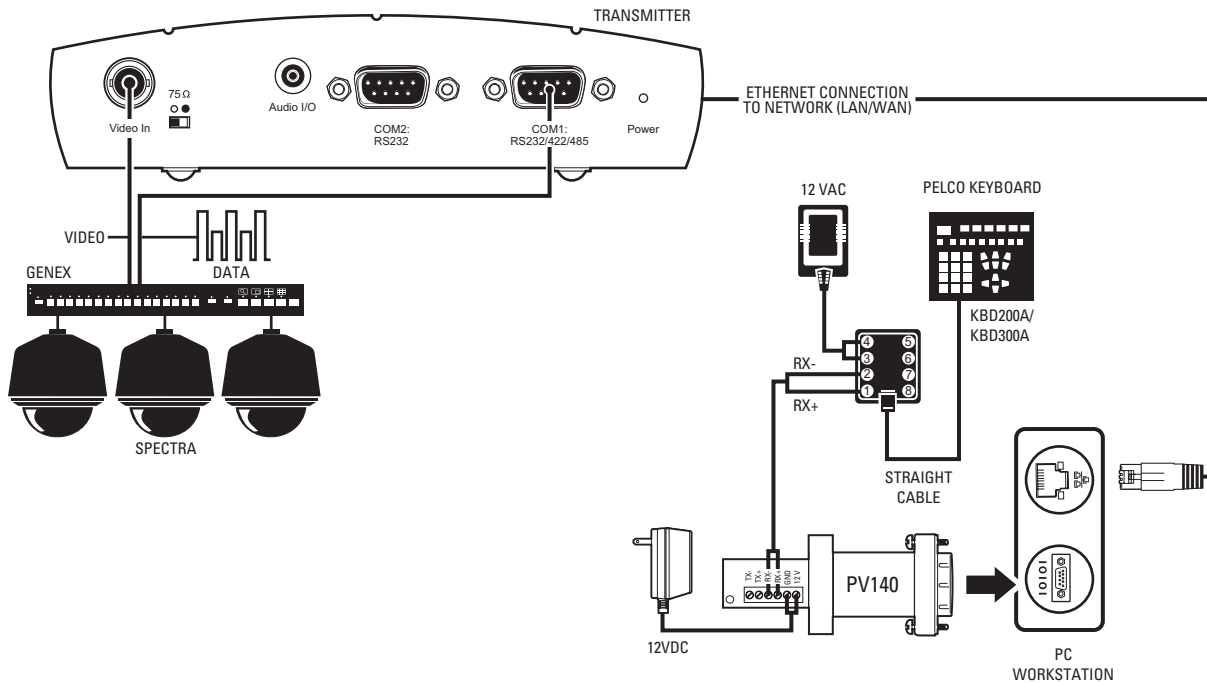

Figure 16. Connection with Pelco Keyboard Control Through a PC (Example Shown with Spectra and Genex)

Hardware Installation

Refer to *Appendix A* for examples of how to connect equipment.

MOUNTING THE NET350 TO THE WALL

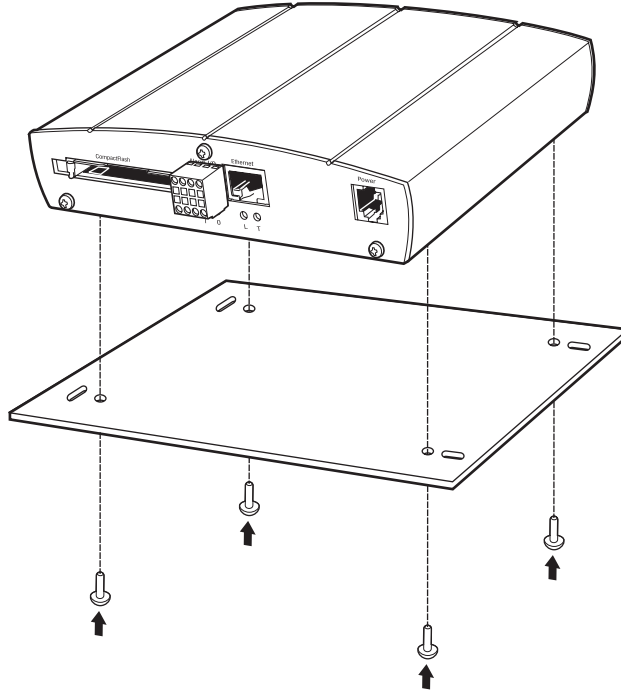

Figure 17. Securing NET350 to Wall Mount Bracket

If desired, the NET350 can be mounted to a wall using the supplied wall mount bracket. To do so:

1. Pry off the clear plastic feet from the bottom of the NET350 unit. (Note the grooves on the underside of the unit. They are involved later in securing the unit to the wall mount bracket.)
2. Refer to Figure 17. Align the grooves on the underside of the NET350 with the four smaller holes in the mount. Install four screws (supplied) through the holes in the bottom of the wall mount. The screws fit in the grooves. Tighten carefully to secure the NET350 to the wall mount. **DO NOT OVER-TIGHTEN**; the screws can damage the aluminum grooves.
3. Attach the mount to the wall with four screws (customer supplied) through the mount's oblong holes. The mount can be attached to the wall with any side of the NET350 pointing up.

CONNECTING VIDEO SOURCES OR DISPLAYS

- The BNC Video In socket of the NET350T transmitter accepts color or black-white sources and automatically detects whether it is PAL or NTSC. The video input has an external switch for termination of 75 ohms.
- The Video Out BNC socket of the NET350R receiver can be connected to any PAL or NTSC video monitor or VCR with a composite PAL or NTSC input. You must select NTSC or PAL on the configuration page for video decoder settings for the NET350R.
- If the video signal is not looped through, terminate the video input by setting the "75 Ω " slide switch (located on the front of the transmitter) to the right.

CONNECTING DATA TERMINALS

The bidirectional data interface ports can be used as control ports for equipment connected to the NET350 (for example, a dome camera with motorized lens).

- The COM1: RS232/422/485 port supports RS-232, RS-422, and RS-485 transmission protocols.
- The COM2: RS232 port supports RS-232 transmission protocols.

PIN ASSIGNMENTS

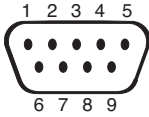

Table A. Pin Assignments

Pin	COM1		COM2
	RS-232	RS-422/485	RS-232
1	DCD (data carrier detect)	–	–
2	RX (receive data)	RX+ (receive data plus)	RX (receive data)
3	TX (transmit data)	TX- (transmit data minus)	TX (transmit data)
4	DTR (data terminal ready)	–	–
5	GND (ground)	GND (ground)	GND (ground)
6	DSR (data set ready)	–	–
7	RTS (ready to send)	TX+ (transmit data plus)	–
8	CTS (clear to send)	RX- (receiver data minus)	–
9	–	–	–

NOTE: Transmission of transparent data is only possible when a video connection has been established.

WARNING: Pay attention to documentation relating to the installation and operation of the equipment being controlled.

CONNECTING AUDIO EQUIPMENT

The NET350 provides an audio channel through the Audio I/O jack. The audio signals are transmitted bidirectionally and simultaneously with the video signals. This allows control of a loudspeaker or door intercom system as required. Bidirectional, full duplex audio applies to box-to-box connections only.

1. Connect a preamplified microphone (monaural line) to the Audio I/O jack on the transmitter.
2. Connect a loudspeaker to the Audio I/O jack on the receiver.

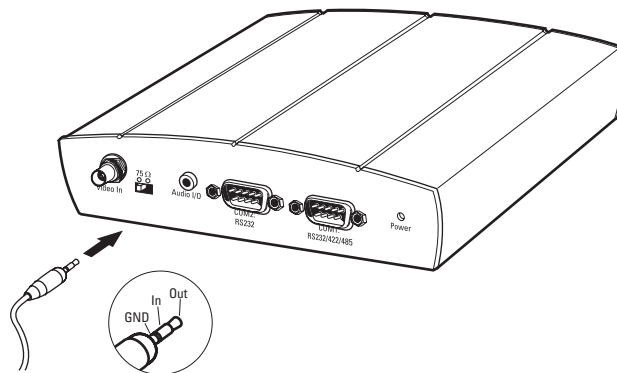

Figure 18. Connecting Audio Equipment

CONNECTING AN ALARM

The NET350 has an alarm input that lets you connect an external signaling device, such as a door contact or motion detector. (Note that there is no motion alarm on a NET350 receiver.) If configured accordingly, an alarm trigger can also set up an automatic connection between the NET350 and the remote station. You can connect switches or contacts directly without a separate power supply.

Do the following to connect an external sensor. Refer to Figure 19.

1. Pull the Alarm I/O terminal block from its plug-in base.
2. Attach conductors to the alarm input and ground conductor terminals. (Insert a small screwdriver tip in the square hole and push hard enough to open the corresponding round hole. Insert the wire in the round hole.)
3. Push the terminal block back on to the plug-in base.

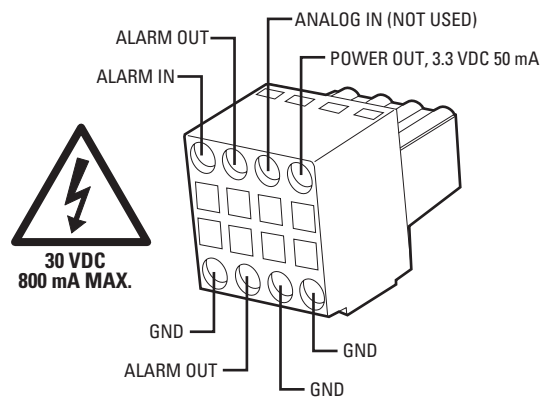
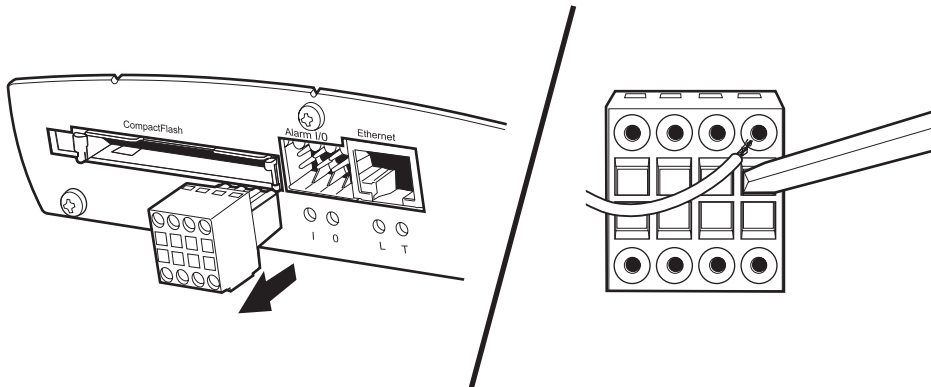

Figure 19. Alarm and Relay Connections

CONNECTING A RELAY

The NET350 has a relay for switching an external device (for example, a light or siren). The relay can be operated from a control page during an active connection or automatically to coincide with certain events. Settings for the relay must be configured (refer to the *Configuration* section).

Do the following to connect a peripheral device (such as a light) that can be activated from a PelcoNet live video page. Refer to Figure 19.

⚠ WARNING: The maximum rating of the relay contact is 30 VDC and 1 A.

1. Pull the Alarm I/O terminal block from its plug-in base.
2. Connect the Alarm Out terminal on the *top* of the block to an external power source and the component to be activated (for example, a light or buzzer). Then use the second wire to connect the Alarm Out terminal on the *bottom* of the block to the external power source and the component. (Insert a small screwdriver tip in the square hole and push hard enough to open the corresponding round hole. Insert the wire in the round hole.)
3. Push the terminal block back on to the plug-in base.

CONNECTING TO A LAN

Refer to Figure 20. You can connect the NET350 to a 10/100BASE-T network either directly or through a hub. To do so, plug a standard Cat5 UTP cable with RJ-45 connectors into the NET350's Ethernet socket.

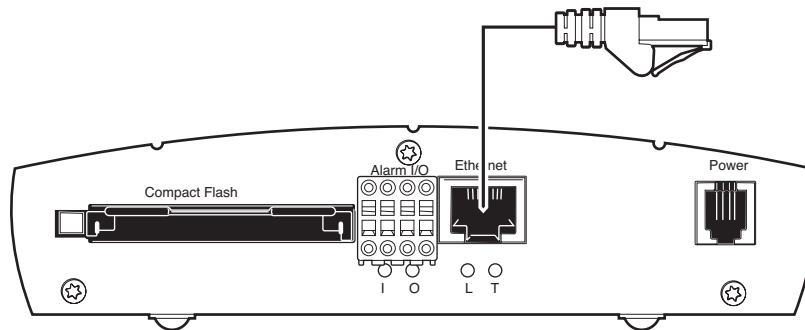

Figure 20. Connecting to the LAN Port

SWITCHING ON POWER

There is no power switch—the unit is ready for operation when it is plugged into an outlet. Do not connect the NET350 to a power source until all other connections have been made.

1. Plug the supplied cable into the NET350's Power socket.
2. Plug the adapter end into an outlet grounded to earth.

The Power LED is red during start-up and turns green when the NET350 is ready to operate. If the network connection is established correctly, the L LED turns green. A flashing yellow T LED means data is moving over the network.

Configuration

BOX-TO-BOX CONNECTION

The following explains a box-to-box connection.

1. First, transmitter and receiver need to be configured appropriately. If the units are supposed to be operated in different subnets, a gateway IP address must be configured. Use the Live video receiver IP address field to address the destination. Enter the settings using either a terminal program or a web browser.
2. Once all addresses are configured, under the terminal program menu, go into the "Rcp+" menu and type **e** to make the connection. Or program the live video receive IP address and enable the live auto connect setting through the web browser. Make sure the unit that will initiate the connection has an alarm IP address that points to the destination unit. After a few seconds, video transmission begins and the camera scene appears on the monitor attached to the receiver.

Instead of using a terminal program or web browser for establishing a connection, you can attach a contact to the alarm input. Make sure the alarm input field on the configuration page for alarm settings is enabled and the connect on alarm field is turned on.

You can use a web browser to connect to either of the two units, even during an active box-to-box connection. This way you can make changes to the configuration and immediately see the result of the setting (for example, when changing video quality). (This is not true for passwords, however.) If you are connected to the transmitter, the camera pictures are sent to the receiver and web browser simultaneously. There will be a short break in the video display on the receiver monitor whenever the web browser requests a new frame. This is especially noticeable with the Server Push feature.

Transparent data is always transmitted automatically between the two units as soon as the connection becomes active. Data bytes entering the interface are transported to the other end transparently. There is no flow control mechanism for the data channel. Overflowing the serial interface will cause data loss.

To sever the connection from either end, in the "Rcp+" menu press **3** (or disable the alarm).

CONFIGURATION TYPES

There are two ways to configure your system:

- A convenient, complete configuration and display of video is accomplished through the built-in HTTP server, which connects to any standard web browser (for example, Internet Explorer). You can then configure using screens and menus. This is the recommended method. Refer to the *Configuration Using a Web Browser* section.
- The most basic configuration is accomplished by connecting a PC to the RS-232 terminal port. You then type in commands and parameters. Refer to the *Configuration Using a Terminal Program* section.

CONFIGURATION USING A WEB BROWSER

To use a web browser the system features a complete HTTP server.

Microsoft's Internet Explorer 5.5 or higher is the recommended browser.

In order for live video images to be decoded, the special ActiveX control file must be installed on your PC. The latest version of the ActiveX platform comes on the PelcoNet CD. Also, the unit will not function without some form of Microsoft's Virtual Machine installed on the PC. Virtual Machine is included on the PelcoNet resource CD that came with your NET350 unit.

GETTING STARTED

NOTES:

- NET-Manager is a program that can make it easier to manage PelcoNet units in local networks. The program and manual (C2901M) are on the resource CD that comes with your PelcoNet unit. Refer to the manual for instructions.
 - The only NET-Manager features available to the NET350 include scanning to see your units' IP and MAC addresses, changing IP addresses, and viewing the setup pages with the browser.
1. Start your web browser.
 2. Connect to the URL **http://IP-Address**, where IP Address is the IP address of the unit you want to configure. Use the standard dot-separated format (x.x.x.x) to enter the address. The home page is displayed along with the video from the camera.



Figure 21. PelcoNet Home Page

The home page is the starting point for any configuration.

The window in the left of the screen is the display area for decoded video.

- Clicking the Pelco logo on any page connects you to the Pelco Internet home page, provided the LAN supports Internet access.
- Click **Video 1** or **Video 2** to choose which live display to view.
- Click **Server Push** for periodically updated stills.
- Click **Control** to access an options screen with links to pages where you can see and control the displayed view. (Refer to the *Web Browser Control Pages* section.)
- Click **Setup** to access an options screen with links to configuration pages. Click any icon on the side or the text itself to transfer to the desired page.

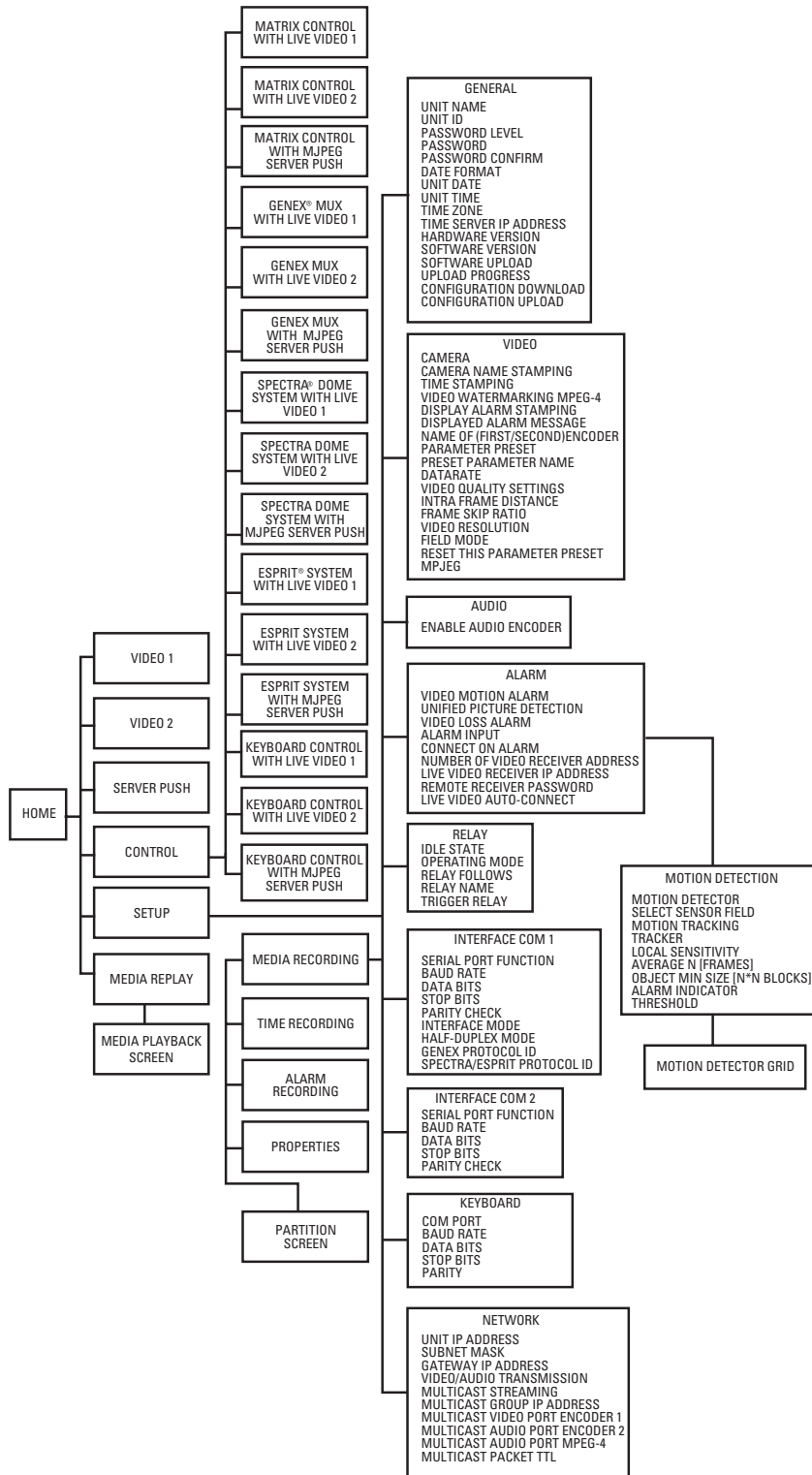

Figure 22. PelcoNet NET350 Menu Tree

SETUP PAGE

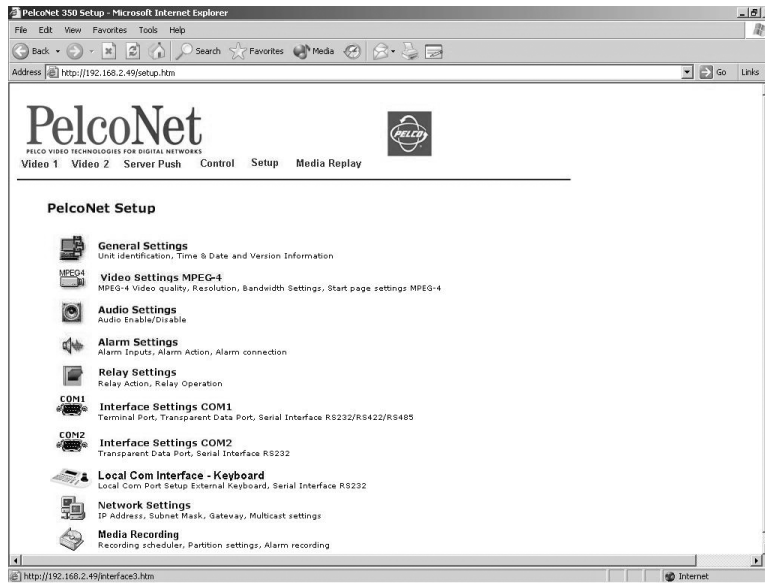

Figure 23. PelcoNet NET350 Setup Page

NOTE: The Set button within a box on a configuration page applies to all the fields within that box. You can change all the fields in a box and then click Set once and all the changes within that box will be saved.

All configuration items are stored in nonvolatile memory so they are kept when the unit is powered down.

Some configurations apply only to transmitters (for example, camera settings) while others apply to both transmitters and receivers. The configuration pages for receivers do not include fields that apply only to transmitters.

CONFIGURATION PAGE FOR GENERAL SETTINGS

The unit identification, password, date and time, time server, version information, and software update settings make up the General Settings configuration page.

All units have a real-time clock set during manufacture. However, time and date can be changed anytime; for example, when the units are operated in different time zones.

Version numbers for the hardware and firmware are for information only. Whenever you need technical support, have these numbers ready.

The screenshot shows the 'PelcoNet 350 General Settings' page in a Microsoft Internet Explorer browser window. The address bar shows 'http://172.16.0.96/general.htm'. The page is organized into several sections:

- Unit identification:** Fields for 'Unit name' and 'Unit ID', with a 'Set' button.
- Password settings:** A 'Password level' dropdown menu, 'Password' and 'Password confirm' text boxes, and a 'Set' button.
- Date and time:** 'Date format' dropdown (set to 'Japan'), 'Unit date' (Wednesday, 2003 / 08 / 27), and 'Unit time' (14 : 42 : 51) with a 'Synchr. PC' button and a 'Set' button.
- Time server:** 'Time zone' dropdown (set to '(UTC -12:00) Dateline Std. Time') and 'Time server IP address' (0.0.0.0) with a 'Set' button.
- Version information:** 'Hardware version' (B0018A43) and 'Software version' (25050105) text boxes.
- Software update:** 'Software upload' with a 'Browse...' button and an 'Upload' button; 'Upload progress' (0%); 'Configuration download' with a 'Download' button; and 'Configuration upload' with a 'Browse...' button and an 'Upload' button.

At the bottom, there is a 'Help on this page?' link and a status bar showing 'Done' and 'Local intranet'.

Figure 24. Configuration Page for General Settings

Configuration Item	Default Setting	Description
Unit name	None	(For future development.) The Unit name identifies the device; for example, in the event of an alarm, this name would be displayed in the video image, depending on the configuration. You can enter up to 31 alphanumeric characters.
Unit ID	None	(For future development.) The Unit ID identifies the device. You can enter up to 31 alphanumeric characters.
Password level	None	<p>Select the password level from the pull-down menu.</p> <p>Access to the NET350 generally is protected with a password to prevent unauthorized use of the unit. There are three password levels.</p> <p> WARNING: Setting a User level password on a transmitter can cause complications on the receiver side in a box-to-box configuration. To avoid this, on the receiver's Alarm Settings configuration page enter the transmitter's IP address and user password in the appropriate fields (live video receiver IP address and remote receiver password). If no User level password is set on the transmitter, then the receiver needs no setup.</p> <ul style="list-style-type: none"> • Service: This is the administrative, and highest, level. This level grants access to all configuration parameters after the current password is entered. <p>IMPORTANT: Service is an administrative account. If you do not set up a Service password, there is no point in setting up User or Live passwords because a user can log in to the unit by entering "service" and then eliminate the User and Live passwords.</p> <ul style="list-style-type: none"> • User: This is the second highest level. This level lets the user view live video and access the control pages. • Live: This is the lowest level. This level does not grant access to configuration pages but allows the unit to be operated (for example, viewing video). <p>If any password level is set, you will always be required to log on to the NET350.</p> <p>For example, if a Live level password is set and you view that unit through the browser, the unit will ask for a user name and password to access any configuration page. If you then try to access the setup page again, the unit will again prompt for a user name and password.</p> <p>Some scenarios that can occur are as follows:</p> <ul style="list-style-type: none"> • If a password is set for the Service level, then the only way to access the setup page is by logging on using the Service user name and the Service level password. • If no password is set for the Service level, then you can log on with the Service user name and no password or you can log on with the Live user name and the Live password you have selected.
Password	None	You can enter or change a password if the unit is accessed in the Service authorization level or if the unit is not protected by a password. Passwords can be changed one at a time only (that is, either Service, User, or Live). Maximum entry is 19 alphanumeric characters. All entered characters will be saved when you click Set ; however, no more than eight asterisks will be displayed when you access the screen next time even if you entered more than eight characters.
Password confirm	None	Re-enter the new password again to guard against typing errors. If the device is not protected by a password, the "No password set" message will be displayed.
Date format	Europe	Use the pull-down menu to select the format for the date: Europe, USA , or Japan.
Unit date	N/A	Enter the current date in MM/DD/YYYY format for the USA, DD.MM.YYYY for Europe, or YYYY/MM/DD for Japan. This is the system date, which is controlled by an internal real-time clock. The day of the week (first entry box) need not be entered and will be automatically adjusted based on the given date.
Unit time	N/A	Enter the current time or click the Synchr. PC button and then click Set to synchronize the NET350 with your computer's system time. This is the system time, which is controlled by an internal real-time clock. This only synchronizes once. (Pelco cannot guarantee the time will be accurate without the use of a time server.)
Time zone	Pacific	Use the pull-down menu to select the time zone for the NET350. This and the Timer Server IP Address settings are important if the internal clock should be synchronized with the time received from a time server on the Internet.
Time server IP address	0.0.0.0	Enter the IP address of a TIME protocol server and then click Set . The time and date are automatically synchronized every two hours to this server. This feature does not adjust for Daylight Saving Time; you should adjust manually as needed.
Hardware version	N/A	Read-only version number of the hardware. This contains unique serial number, type of hardware, and revision.
Software version	N/A	Read-only firmware version number. This is important information should you need technical support.

Configuration Item	Default Setting	Description
Software upload	N/A	Units have flash EPROMs for firmware upgrades in the field. These upgrades can be done directly from the web browser. Enter the name of the file containing the upgrade, or locate it using the Browse button. Then click the Upload button.
Upload progress	0%	This field shows the percentage of the upload that has been completed.
Configuration download	N/A	Clicking the Download button saves the current configuration of the PelcoNet NET350 transmission system to a PC file.
Configuration upload	N/A	This copies a file from a PC to the NET350. Enter the name of the file containing the configuration, or locate it using the Browse button. Then click the Upload button to overwrite the configuration with the configuration stored in the named file.

CONFIGURATION PAGE FOR MPEG-4 VIDEO SETTINGS

MPEG-4 encoder and live page settings make up the configuration page for MPEG-4 video settings. The table that follows describes configuration items.

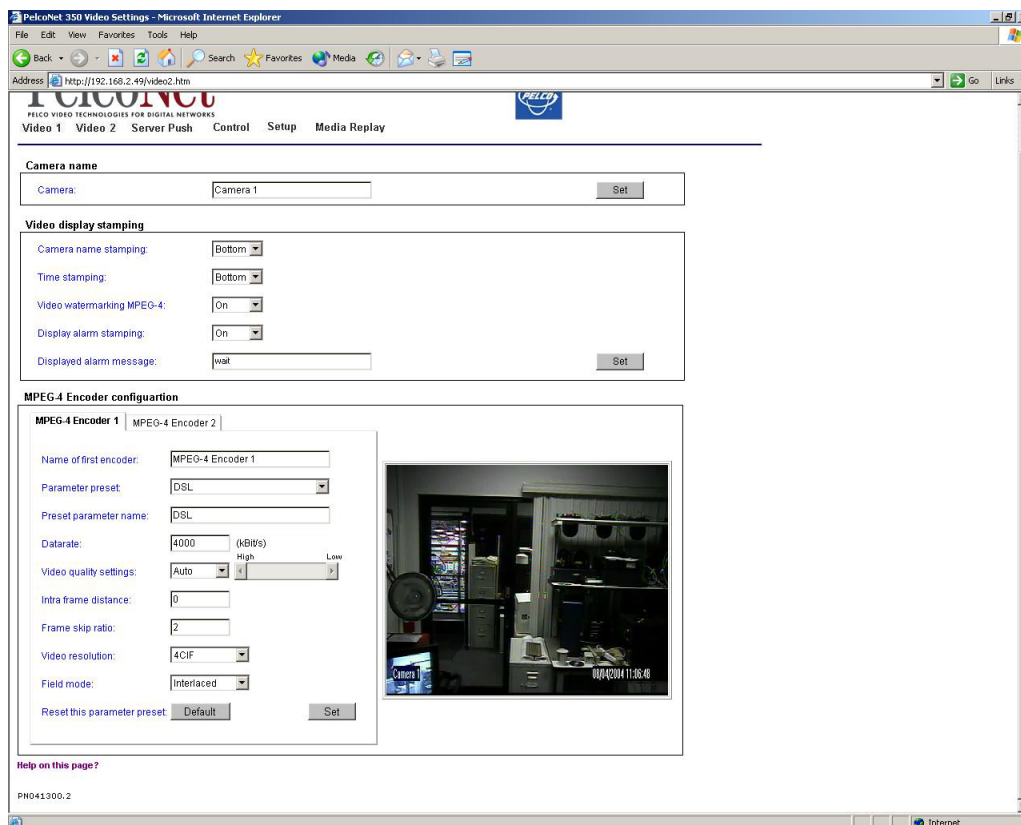

Figure 25. Configuration Page for MPEG-4 Video Settings (Only One Example Shown)

NOTE: The receiver monitor displays only Encoder 1 settings; Encoder 2 settings are not displayed.

Configuration Item	Default Setting	Description
Camera	Camera 1	Enter a camera name.
Camera name stamping	Off	Use the pull-down menu to select a screen option (Top or Bottom) where the camera name will be displayed. Or select Off.
Time stamping	Off	Use the pull-down menu to select a screen position (Top or Bottom) where the current time will be displayed. Or select Off.
Video watermarking MPEG-4	On	Use the pull-down menu to select whether the MPEG-4 data stream will be stamped with a watermark (On) or not (Off). A green rectangle will be stamped on the decoded signal of the validated data stream.
Display alarm stamping	Off	Use the pull-down menu to select whether a message will be displayed in the event of an alarm.
Displayed alarm message	N/A	Enter the message to be displayed in the event of an alarm (31 alphanumeric characters maximum).
MPEG-4 Encoder 1/2 (tab)	MPEG-4	Click the tab to choose whether to set parameters for either encoder 1 or encoder 2. The Encoder 1 selected button's text will be bold.
Name of (first or second) encoder	(Name of first encoder)	Clicking the MPEG-4 Encoder 1 or 2 tab changes the title of, and entry in, this field. If desired, enter a name other than the programmed name to identify video 1 or video 2 (24 alphanumeric characters maximum). (Changing the name here also changes it on the tab.)
Parameter preset	1	Use the pull-down menu to select a setting (1-8) that corresponds to a predefined profile in the Preset Parameter Name field below. The profile changes as you change the setting. These predefined profiles are a starting point from which you can make custom adjustments, if desired.
Preset parameter name	high res. (4CIF)	This field describes the profile associated with the setting in the Parameter Preset field above. This field changes automatically. The profiles are predefined and optimized for different transmission paths. The profiles are 1 = high res. (4CIF) for connections with high bandwidth and high resolution of 704 x 576 pixels 2 = low delay (half D1) for connections with high bandwidth and motion-optimized resolution of 352 x 448 pixels 3 = low bandw. (CIF) for connections with lower bandwidth and resolution of 352 x 288 pixels 4 = DSL for ADSL connections 5 = ISDN (2B) for ISDN connections over two B channels 6 = ISDN (1B) for ISDN connections over one B channel 7 = MODEM for modem connections 8 = GSM for GSM modem connections (Note that QCIF does not support displaying camera name stamping, time stamping, and display alarm stamping.)
Datarate	5000	The data rate figure in this field changes automatically according to the setting you choose in the Parameter Preset field.
Video quality settings	Auto	This setting adjusts the value between video quality and image frame rate. Use the pull-down menu to choose either Auto or Manual. <ul style="list-style-type: none"> If you choose Auto, an optimized value is adjusted automatically. If you choose Manual, you can change the value between high quality and low quality on the slide bar at the right.
Intra frame distance	0	Enter a value to change the size of the frames within the MPEG-4 video stream.
Frame skip ratio	1	Enter a skip value for images. <ul style="list-style-type: none"> If you enter 1, all images are encoded. If you enter 2, every second image is encoded. Use this setting if you want low bandwidth and higher quality.
Video resolution	CIF	Use the pull-down menu to choose the video resolution (QCIF, CIF, 2CIF, 4CIF, or custom) for viewing and recording. See the Preset Parameter Name field for descriptions of options.
Field mode	Interlaced	This setting lets you select the field mode for video transmission. Use the pull-down menu to select one of the following: <ul style="list-style-type: none"> Interlaced – Interlaced mode on. Setting improves video quality on moving objects. Progressive – Interlaced mode off.
Reset this parameter preset	N/A	Click the Default button to return the settings to the factory defaults.

CONFIGURATION PAGE FOR VIDEO DECODER SETTINGS (RECEIVER ONLY)

Just two fields — video monitor name and video output standard — make up the configuration page for video decoder settings. The following table describes configuration items.

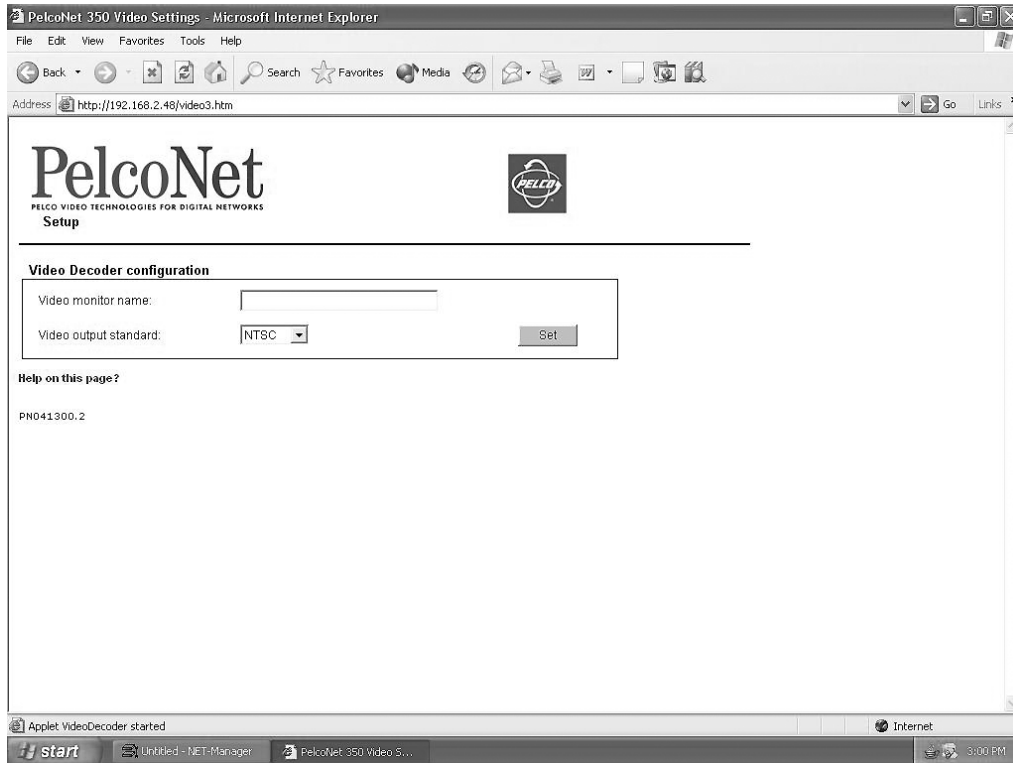

Figure 26. Configuration Page for Video Decoder Settings (Receiver Only)

Video monitor name	N/A	Enter a name (31 characters maximum for the monitor).
Video output standard	NTSC	For devices that also function as receivers, select the video standard for the monitor output (NTSC or PAL). Reset the unit if you change this value.

CONFIGURATION PAGE FOR AUDIO SETTINGS

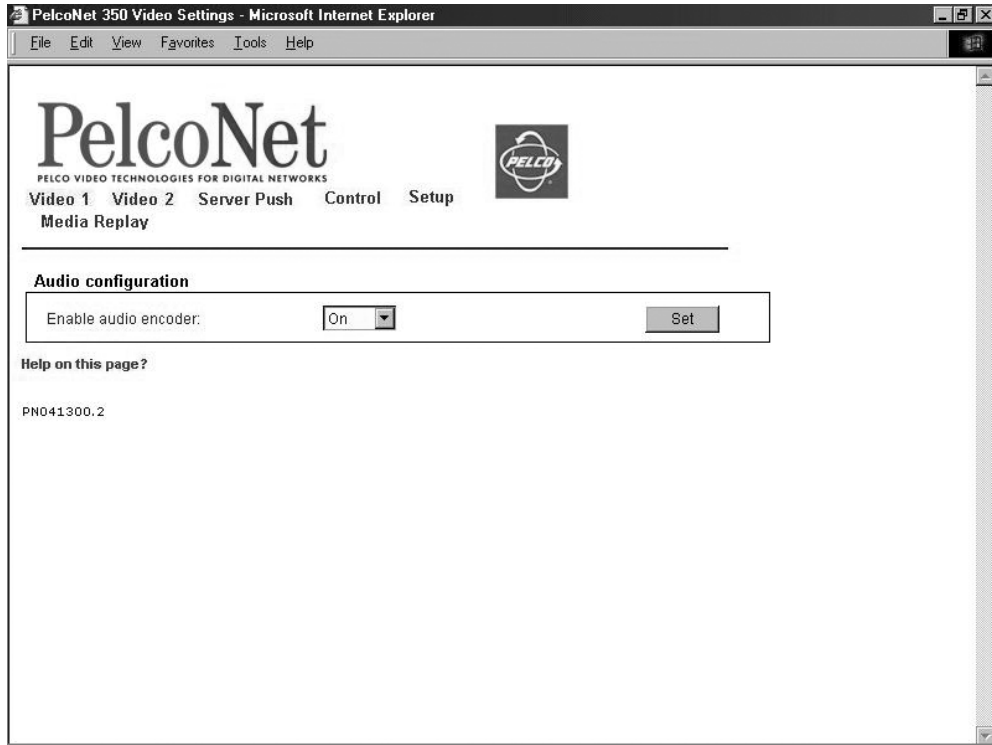

Figure 27. Configuration Page for Audio Settings

Configuration Item	Default Setting	Description
Enable audio encoder	Off	Use the pull-down menu to turn on/off audio.

CONFIGURATION PAGE FOR ALARM SETTINGS

The PelcoNet NET350 transmission system is not only a multimedia gateway but also a security device and, therefore, has many features related to security applications. The configuration page for alarm settings lets you configure your unit for surveillance applications. In most surveillance-related applications, the receiver is located in a secure alarm center-type environment while the transmitter is located at the site to be monitored.

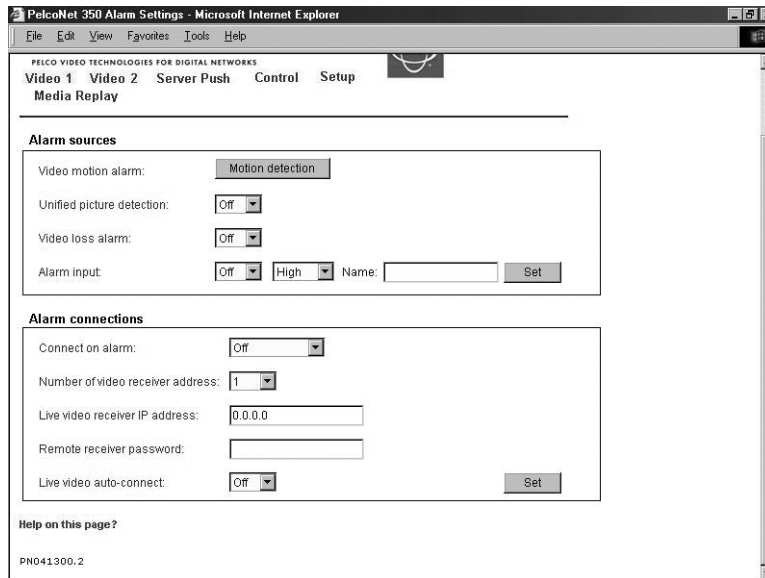

Figure 28. Configuration Page for Alarm Settings

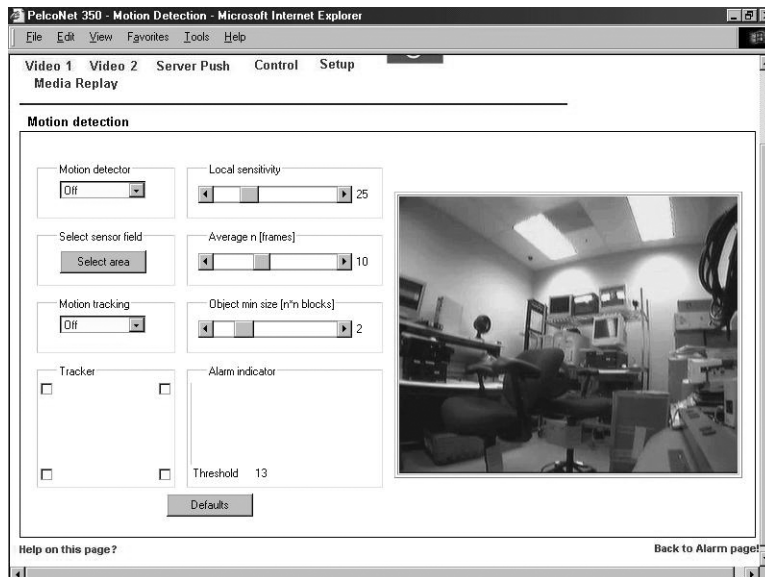

Figure 29. Motion Detection Screen

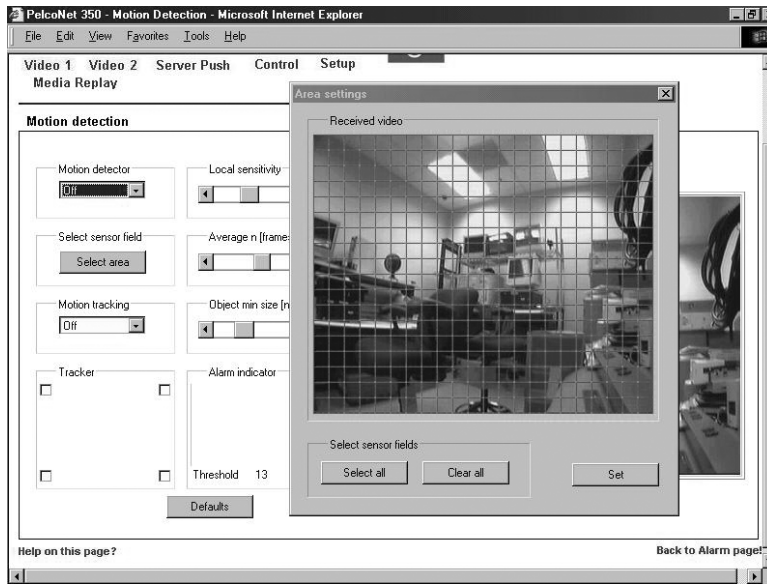



Figure 30. Motion Detection Grid Screen

The set of alarm features is explained below.

Configuration Item	Default Setting	Description
Video motion alarm	N/A	<p>The system has a video motion detection feature. The video scene is monitored constantly for relevant motion.</p> <p>NOTE: Use of the motion detection feature is recommended only indoors and under controlled lighting conditions; it is not recommended in dim lighting.</p> <p>The following conditions must be met for motion detection to function:</p> <ul style="list-style-type: none"> • Motion detection must be activated. • At least one cell must be activated. • Sensitivity must be set higher than zero. <p>To set motion detection, do the following:</p> <ol style="list-style-type: none"> 1. Click the Motion detection button to access the Motion Detection screen. (Refer to Figure 29.) Click Default to get the default settings for motion detection. 2. Select On from the Motion detector pull-down menu to trigger an alarm in the event of movement. 3. Click the Select area button to display a window with a grid superimposed on it (refer to Figure 30). Select the cells in the image you want the system to monitor for motion. You can use the Select all and Clear all buttons. The default is all cells selected (red). To set an individual cell, click it with the left mouse button (it will turn red). Click the right button to deselect a cell (which will turn white). Select or deselect multiple cells by holding down the left or right mouse button and dragging. Release when finished. Click the Set button. 4. Use the Motion tracking pull-down menu to turn on/off tracking. (Note that motion tracking overrides motion detection.) 5. The Tracker box indicates and controls the direction of motion detection. You can set motion detection to operate in one direction only by removing the check mark in the opposite direction. (This advanced feature must be set up precisely. Pelco recommends extensive setup testing in order to get the expected results.) 6. Use the Local sensitivity slide bar to set detection sensitivity. You need to adapt sensitivity to the respective environment and the acceptable false alarm rate: for a lower false alarm rate select a lower sensitivity and vice versa. Experiment to find the best setting. 7. Use the Average n [frames] slide bar to define how much motion must be detected before an alarm will be released. If the value is high, even movement over a small time period triggers an alarm. If the value is low, movement over a longer period is required to trigger an alarm. 8. Use the Object min size [nxn blocks] slide bar to designate the minimum number of cells in the frame a moving object must fill to trigger an alarm. You can set the value between 1*1 and 6*6 (2*2 is recommended). If the size of the object in the picture exceeds the value you set, motion detection triggers an alarm. 9. The Alarm indicator box lets you set a threshold so an alarm is triggered only if the sensitivity of the video sensor is exceeded. Thus, something such as background noise caused by the camera can be filtered to avoid unwanted alarms. The blue line indicates the alarm threshold. Any value exceeding this produces an alarm signal. Components of the motion signal generating the alarm are indicated in red. Pull up or down on the blue line to observe the motion detector. 10. Click Back to Alarm page! when finished.
Unified picture detection	Off	Use the pull-down menu to turn on/off this feature, which gives an alarm when the picture becomes too blurry.
Video loss alarm	Off	If you select On , the signal from the video source (the camera in most cases) is monitored constantly for interruption. If no signal is received, the NET350 triggers the alarm.
Alarm input	Off/High	<ol style="list-style-type: none"> 1. Select On from the pull-down menu if you want to activate an alarm through an external alarm sensor. 2. Select High or Low for the voltage level to activate the alarm. 3. Enter a name for the alarm input to be displayed on the screen if an alarm is activated (31 alphanumeric characters maximum).

Configuration Item	Default Setting	Description
Connect on alarm	Off	<p>The alarm functions would have little effect without automatically triggering corresponding actions. Select On for automatic connection to the video receiver's IP address. The idea is to provide a remote monitoring station with live video in case of an alarm. (If you want both motion and alarm input to activate an alarm, set this field to On. If set to motion only, motion alarms will activate an alarm but no input alarms will be recognized.)</p> <p>This feature can be useful even for many applications not related to alarm conditions. One example is a video-equipped door entry system: when the doorbell is pressed, a contact closes and the connected transmitter automatically connects to a receiver. Full duplex audio can provide verbal communication, while the relay output can open the door remotely.</p> <p>Select Follows input to specify that the connection remain as long as the alarm is active. (If Follows input is set, motion will not activate an alarm.) Select Follows motion alarm to specify that the alarm will turn on when motion is detected and turn off 10 seconds after motion is no longer detected. (If Follows motion alarm is set, input will not activate an alarm.)</p>
Number of video receiver address	1	<p>The NET350 can store up to 10 different alarm IP addresses. When an alarm occurs, a connection is established to the first address. Up to 10 separate addresses can be added should the first address not accept the call.</p> <p>Use the pull-down menu to select how many additional addresses to contact, if necessary. (Add the IP addresses in the next field.)</p>
Live video receiver IP address	0.0.0.0	Enter the IP addresses (10 maximum) of the receivers to be notified in the event of an alarm.
Remote receiver password	N/A	<p>Enter the password for the remote unit if it is protected by a User or Live password.</p> <p> WARNING: Setting a User level password on a transmitter can cause complications on the receiver side in a box-to-box configuration. To avoid this, on the receiver's Alarm Settings configuration page enter the transmitter's IP address and user password in the appropriate fields (live video receiver IP address and remote receiver password). If no User level password is set on the transmitter, then the receiver needs no setup.</p>
Live video auto-connect	Off	Select On if at each restart an active connection should be set up automatically to the receiver's IP address. The auto-connect feature guarantees an active connection to the receiver's alarm IP address even after connection breakdown or network failures. As soon as communication is restored, the connection is reinstated. On a receiver, this feature is enabled to establish a connection to a transmitter automatically.

CONFIGURATION PAGE FOR RELAY SETTINGS

You can use the configuration page for relay settings to specify parameters such as normally open or normally closed switching and bistable and monostable operation of the output.

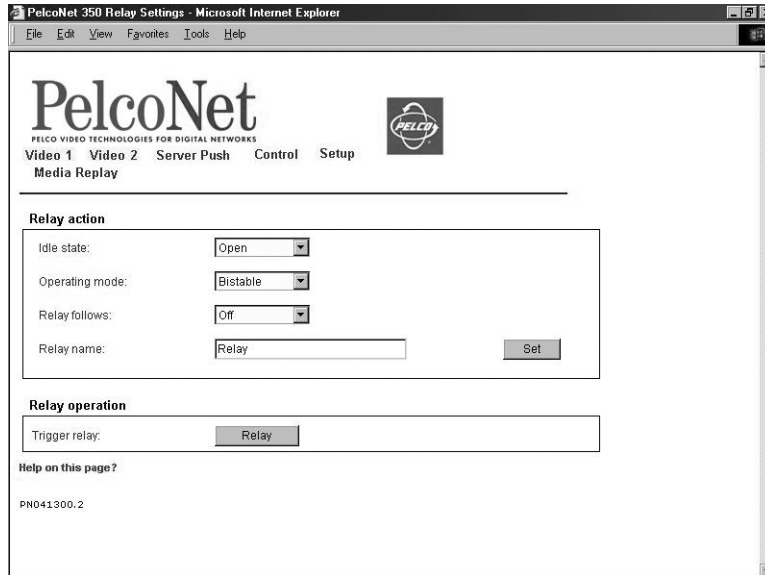

Figure 31. Configuration Page for Relay Settings

Configuration Item	Default Setting	Description
Idle state	Open	Select Open (N.O. at zero current) if the relay will operate as a normally open contact or Closed (N.C. with current) if it will operate as a normally closed contact.
Operating mode	Bistable	Select the relay's operating mode. <ul style="list-style-type: none"> When you select the default Bistable mode, the relay will stay in the idle or active state for an indefinite period. (For example, select Bistable if a floodlight activated by an alarm is to remain switched on at the end of the alarm.) When you select a time period (monostable mode), the relay automatically falls back to the idle state after a predefined period expires. (For example, select 10 s if a siren triggered by an alarm is to sound for 10 seconds.) The choices on the pull-down menu are Bistable, 0.5 s, 1 s, 2 s, 5 s, 10 s, and 60 s.
Relay follows	Off	Select from the pull-down menu an event that will activate the relay. A typical application is to have the relay follow the status of the alarm input; for example, to power peripheral equipment or even the camera itself. Select from the following: <ul style="list-style-type: none"> Off: Relay does not operate. Connection: Relay operates whenever you open live video and will turn off when you exit live video. Video alarm: Relay operates when there is loss of the video signal. Motion alarm: Relay operates when there is motion alarm. Local input: Relay operates by an external alarm sensor. Remote input: Relay operates by a switching contact from a remote location.
Relay name	Relay 1	Enter a name for the relay that will appear on the Live page (31 alphanumeric characters maximum).
Trigger relay	N/A	Click the Relay button to switch the relay manually (for example, as a test or to allow a door to be opened).

CONFIGURATION PAGE FOR COM 1 INTERFACE SETTINGS

You can use this configuration page to set the parameters of the COM 1 RS-232/422/485 serial interface port.

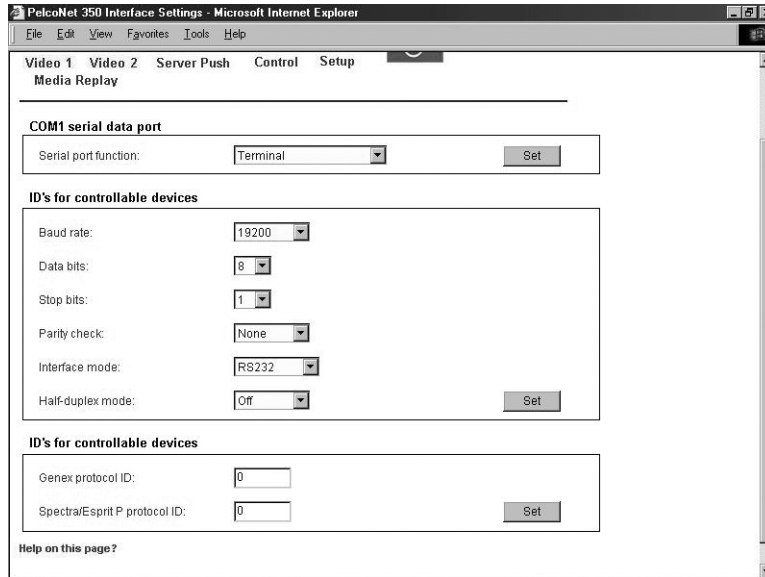

Figure 32. Configuration Page for COM 1 Interface Settings

Configuration Item	Default Setting	Description
Serial port function	Terminal	Use the pull-down menu to select a controllable device from the pull-down menu: Terminal, Transparent, or Pelco Prot (protocol). If the port must transmit data transparently, select Transparent . You can use Pelco Prot to send any kind of control data for a Spectra, Esprit, Genex, or a Pelco matrix.
Baud rate	19200	Use the pull-down menu to select a transmission rate from 600 to 115200 baud. Refer to <i>Appendix A</i> for settings.
Data bits	8	The number of data bits is set at 8 per character.
Stop bits	1	Use the pull-down menu to select the number of stop bits (1 or 2) per character. Refer to <i>Appendix A</i> for settings.
Parity check	None	Use the pull-down menu to select the type of parity check (None, Even, or Odd). Refer to <i>Appendix A</i> for settings.
Interface mode	RS232	Use the pull-down menu to select the required protocol for the port (RS232 or RS422/485). Use RS-232 for two-wire communication (TXD and RXD) and RS-422 for four-wire communication (TX+, TX-, RX+, RX-). (RS-485 is not normally used except in advanced applications.)
Half-duplex mode	Off	This mode allows NET350 to receive data only and not transmit data. If you choose this RS-232 mode, by selecting On, camera control data is transferred automatically to COM 1, which is a serial interface on the unit's rear panel to which you can connect a PC. This mode supports data flow control. (Refer to Table A.) Buffered mode also transfers data input to COM 1. Depending on the equipment used, the Serial Port Function field may have to be set to Transparent if sending any control data.
Genex protocol ID	N/A	Enter the address of the Genex unit with which you want to communicate.
Spectra/Esprit protocol ID	N/A	Enter the address of the Spectra or Esprit unit with which you want to communicate. This must match the P-protocol address of the Spectra or Esprit unit.

CONFIGURATION PAGE FOR COM 2 INTERFACE SETTINGS

You can use this configuration page to set the parameters of the COM2 RS-232 serial interface port.

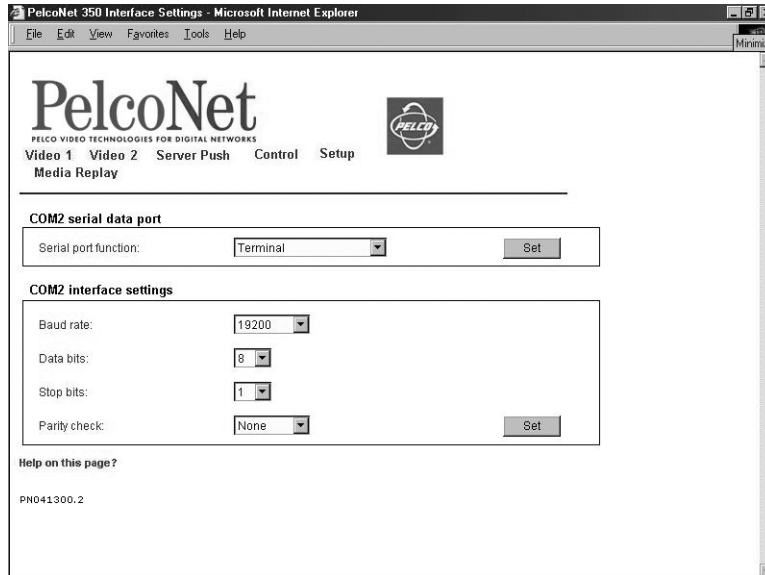

Figure 33. Configuration Page for COM 2 Interface Settings

Configuration Item	Default Setting	Description
Serial port function	Terminal	Use the pull-down menu to select the function for serial port 2 from the pull-down menu: Terminal, Transparent, or Pelco Prot (protocol). If the unit will be operated from a terminal, select Terminal . If the port must transmit data transparently, select Transparent . You can use Pelco Prot to send any kind of control data for a Spectra, Esprit, Genex, or a Pelco matrix.
Baud rate	19200	Use the pull-down menu to select a transmission rate from 600 to 115200 baud. Refer to <i>Appendix A</i> for settings.
Data bits	8	The number of data bits is set at 8 per character.
Stop bits	1	Use the pull-down menu to select the number of stop bits (1 or 2) per character. Refer to <i>Appendix A</i> for settings.
Parity check	None	Use the pull-down menu to select the type of parity check (None, Even, or Odd). Refer to <i>Appendix A</i> for settings.

CONFIGURATION PAGE FOR LOCAL COM INTERFACE – KEYBOARD

You can use this configuration page to set the parameters for a local Com port so you can connect a Pelco keyboard to your computer. This lets you control a device through the keyboard; for example, a camera can be controlled from the browser with the Pelco keyboard. You can also use this feature to transmit serial data from your computer to the PelcoNet unit, or vice versa.

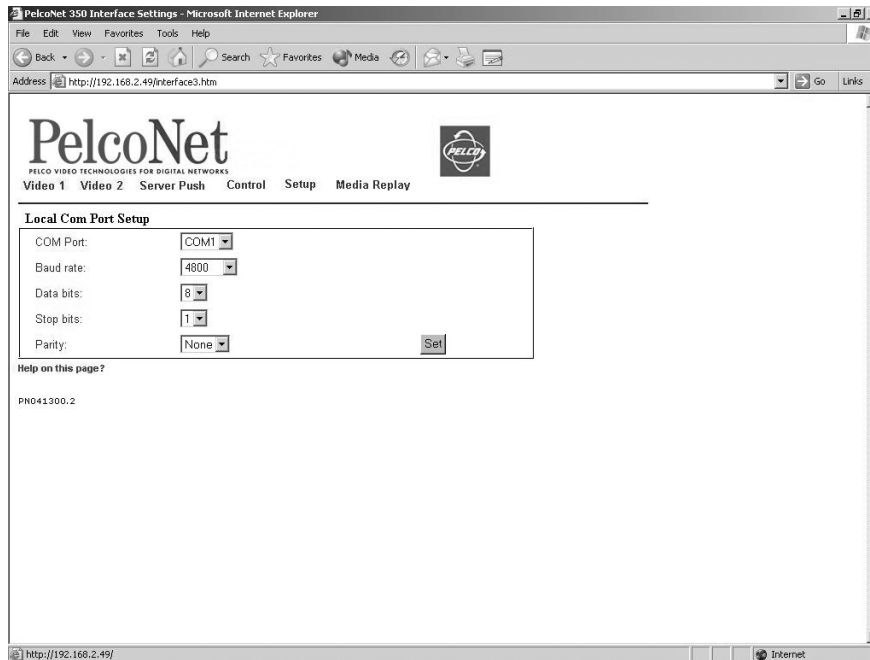

Figure 34. Configuration Page for Local Com Interface – Keyboard

Configuration Item	Default Setting	Description
COM port	COM1	Use the pull-down menu to designate a free COM port on the PC to which you will connect the Pelco keyboard.
Baud rate	600	Use the pull-down menu to select a transmission rate from 600 to 115200 baud. Refer to <i>Appendix A</i> for settings.
Data bits	8	The number of data bits is set at 8 per character.
Stop bits	1	Use the pull-down menu to select the number of stop bits (1 or 2) per character. Refer to <i>Appendix A</i> for settings.
Parity	None	Use the pull-down menu to select the type of parity check (None, Even, or Odd). Refer to <i>Appendix A</i> for settings.

To use this feature, do the following:

1. On the PelcoNet NET350 Setup Page (Figure 23), select **Local Com Interface – Keyboard**. Then select the parameters (Com port, baud rate, etc.) as listed in the table above.
2. You must also change the local PC's Com port configuration (**Start > Settings > Control Panel > Administrative Tools > Computer Management > Device Manager > Ports [COM & LPT] > COM1 or COM2** [depending on the Com port to which the keyboard will be connected]). The configuration of this Com port should be the same as the configuration at the PelcoNet browser.
3. Connect the Pelco keyboard to the COM interface on your PC. This is the COM port that you designated in step 2. (Refer to Figure 54 in *Appendix A* for a connection example.) If the keyboard uses RS-422/485, a converter will be required to use it on an RS-232 COM port of your computer.
4. On the PelcoNet NET350 Setup Page (Figure 23), select **Interface Settings COM1 or Interface Settings COM2**. Use the pull-down menu to set the COM1/COM2 serial data port to **Transparent**. Also set the baud rate for the connected external device you want to control.
5. Finally, from the Device Controls page (Figure 42), select **Keyboard**. This takes you to the "Keyboard Control with live video" page (Figure 47). The COM port is open and you can send transparent data from your PC COM port to the PelcoNet COM port, and vice versa.

CONFIGURATION PAGE FOR NETWORK SETTINGS

Network and routing information make up the configuration page for network settings. These settings are used to integrate the NET350 into an existing network. The table that follows describes the configuration items.

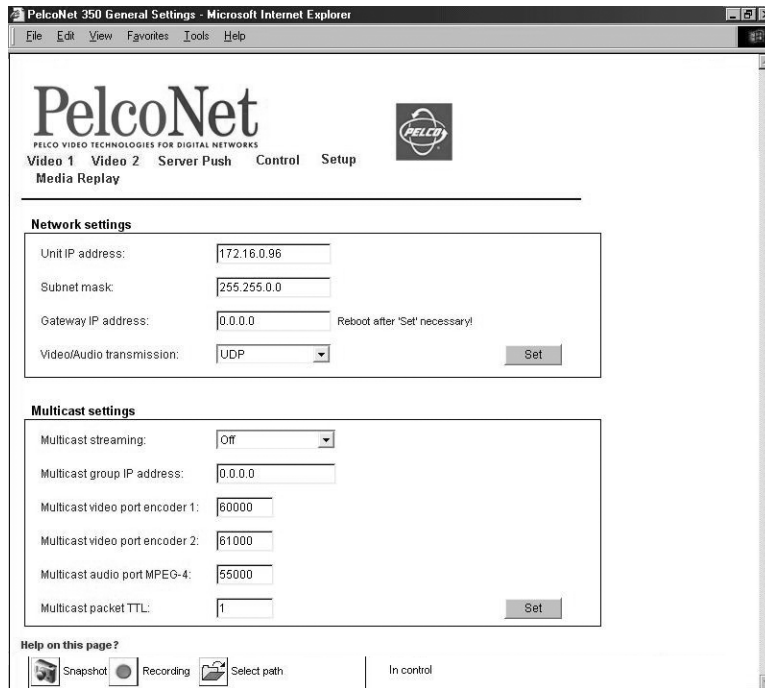

Figure 35. Configuration Page for Network Settings

Configuration Item	Default Setting	Description
Unit IP address	10.0.0.1 (transmitter) or 10.0.0.2 (receiver)	Enter a unique IP address that is valid for your network. The preconfigured default IP address allows for easy configuration in closed environments. You can use a cross-over cable to connect directly to a PC. NOTE: Changing the IP address also affects the current browser connection. You will have to reset the NET350 and enter the new URL to regain connectivity to the unit.
Subnet mask	255.255.0.0	Enter a valid subnet mask for your network.
Gateway IP address	0.0.0.0	Enter the IP address of the router if the unit is to establish a connection outside of the local network. This is typically used in a WAN environment. This field can otherwise remain empty (0.0.0.0).
Video/Audio transmission	UDP	Use the pull-down menu to select the means of transmission. Select TCP (Port 80) to send data through a firewall. Select UDP for communication between local networks.
Multicast streaming	Off	Use the pull-down menu to select MPEG-4 for multicast streaming mode. Besides a one-to-one connection between a transmitter and a receiver (unicast), the NET350 lets you connect a number of receivers to receive the video signal simultaneously. This is achieved by distribution of a single data stream on the network itself to a number of receivers in a defined group (multicast). With MPEG-4 selected and a valid multicast group address selected in the Multicast Group IP Address field, the NET350 operates in multicast mode (data stream duplicated over the network). When multicast streaming is turned off, operation resorts to unicast mode.
Multicast group IP address	0.0.0.0	This is the Multicast IP address. (Network hardware such as switches, hubs, routers, etc. must support the multicasting protocol, ICMP.) This field sets PelcoNet to use the multicasting protocol, which allows more efficient use of bandwidth. The IP range is 224.0.1.0 through 238.255.255.255. Some IP addresses may be reserved for system resources. Contact your network administrator for more information.

Configuration Item	Default Setting	Description
Multicast video port encoder 1	60000	Enter the port address for the video encoder 1 MPEG-4 data stream.
Multicast video port encoder 2	61000	Enter the port address for the video encoder 2 MPEG-4 data stream.
Multicast audio port MPEG-4	55000	Enter any port greater than 1024 that is not in use.
Multicast packet TTL	1	Enter the number of hops for the packet to live. TTL stands for <i>time to live</i> . This setting defines the lifetime of multicast packages in the network. If multicast traffic is to be transmitted over routers and switches, this setting is important in adjusting the lifetime of the package to the requirements of the network.

CONFIGURATION PAGES FOR MEDIA RECORDING

Time, alarm, and recording properties information make up these configuration pages. Use these pages to set up local recording onto the NET350 (using the CompactFlash interface). These settings let you configure your unit for different recording situations. The table that follows describes items that appear on all three media recording configuration pages (Time, Alarm, and Properties).

NOTE: The link to these pages will not appear if the unit is powered up without a CompactFlash card inserted. The link appears only after inserting the card and resetting the unit. To reset the unit, type a forward slash (/) and **reset** at the end of the unit's address in the Internet Explorer browser address window, and then press **Enter**.

Configuration Item	Default Setting	Description
Partition selection	N/A	Use the pull-down menu to select which partition you want to view information about or change.
Stop/Start (buttons)	N/A	These buttons activate and deactivate time and alarm recording for the selected partitions. Once you click the Start button to activate time or alarm scheduling, you cannot make changes or view other partitions until you stop the scheduler with the Stop button.
Time/Alarm/Properties (tabs)	Time recording	Click a tab to select the desired recording or properties page.
Recording active	N/A	The disk icon spins to show that recording is taking place currently.
Enter partition settings! (button)	N/A	Click this button (located in lower right corner) to access a screen that shows how partition resources are allocated; and how much free space remains. (Refer to Figure 36.) From here you can access a wizard to set up partitions (eight partitions maximum can be set per hard disk), or delete existing partitions. Add partition button: Click this button to access a wizard that lets you add, name, and designate the values for a partition. A chart on the partition allocation screen will show how resources are divided among the partitions. Delete partition button: Highlight a partition and then click this button to remove the partition. Click Set when finished, and then click Back to HD Scheduler page! to return to the Time Recording page.

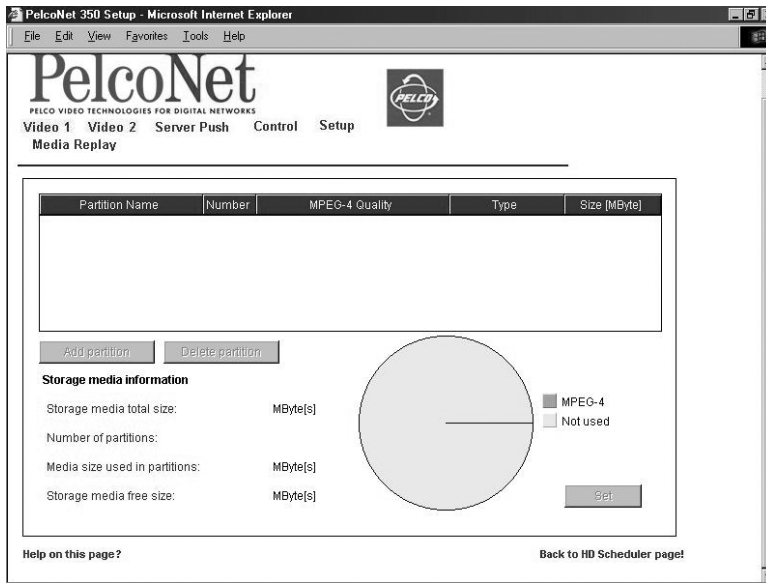

Figure 36. Partition Settings Page

Configuration Page for Time Recording

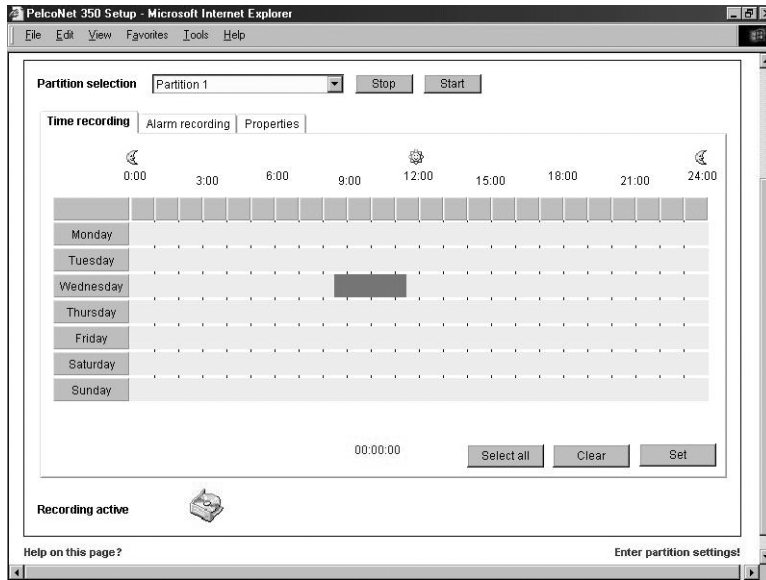

Figure 37. Configuration Page for Time Recording Settings

This page lets you set the times to record during a seven day period. Click the **Time recording** tab to access this page.

Configuration Item	Default Setting	Description
(time recording scheduler grid)	N/A	<p>This grid allows up to 16 different recording times per day in a seven-day period.</p> <ul style="list-style-type: none"> To select a recording time, hold down the left mouse button on the desired starting day and time, and then drag to the desired stopping time and release. You can extend recording time by dragging from the point at which you stopped. A display below the grid shows the exact time. To deselect a recording time, click the right mouse button on the time to be removed. You cannot shorten the time without clearing the time entirely. If you wish continuous recording for the entire week, click the Select all button. To clear everything for the week, click the Clear button. <p>Click the Set button when finished. Then you must click the Start button to activate the scheduler.</p>

Configuration Page for Alarm Recording

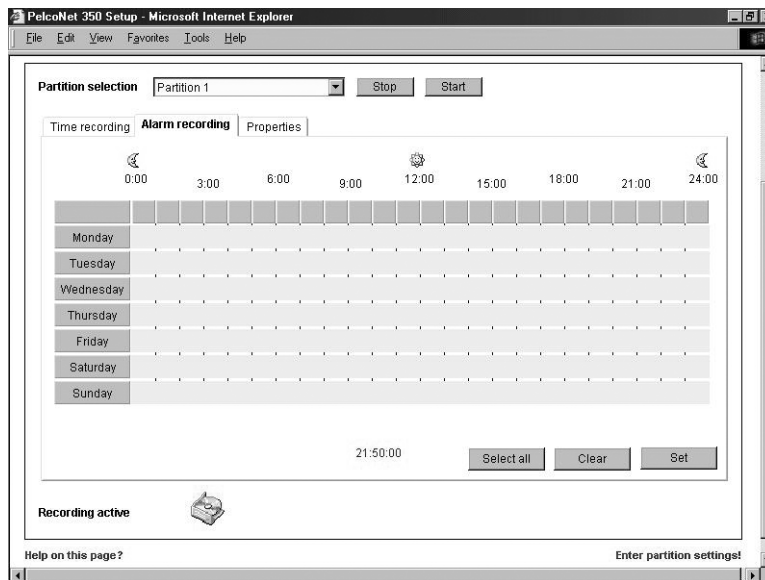

Figure 38. Configuration Page for Alarm Recording Settings

This page lets you designate when particular alarms will be active for recording. Click the **Alarm recording** tab to access this page. (You must first have at least one alarm selected in the **Number of alarms** field on the Properties page to access the Alarm Recording page.)

Configuration Item	Default Setting	Description
(alarm recording scheduler grid)	N/A	<p>This screen lets you set times when an alarm will trigger recording. (You must choose either motion alarm or alarm input on the Properties screen first.)</p> <ul style="list-style-type: none"> To select an alarm recording time, hold down the left mouse button on the desired starting day and time, and then drag to the desired stopping time and release. You can extend recording time by dragging from the point at which you stopped. A display below the grid shows the exact time. To deselect an alarm recording time, click the right mouse button on the time to be removed. You cannot shorten the time without clearing the time entirely. If you wish continuous recording for the entire week, click the Select all button. To clear everything for the week, click the Clear button. <p>Click the Set button when finished. Then you must click the Start button to activate the scheduler.</p>

Configuration Page for Properties

The screenshot shows a web browser window titled "PelcoNet 350 Setup - Microsoft Internet Explorer". The main content area is a configuration page for "Partition 1". At the top, there are "Stop" and "Start" buttons. Below this, there are three tabs: "Time recording", "Alarm recording", and "Properties", with "Properties" being the active tab. The "Properties" tab contains the following settings:

- Partition name: Partition 1
- Partition number: 1
- Type of recording: Linear mode
- Video recording: Video 1, Video 2
- Number of alarms: 1
- Used alarmtracks from partition: 0 / 1
- Alarm recording time: 15 sec, Pre-alarm: 45 sec, Post-alarm
- Alarm recording on: Motion alarm, Alarm input
- Partition total size: 41 MByte[s]
- Used filetracks from partition: 2 / 128
- Remaining for recording: 0 Day[s] 0 Hour[s] 0 Minute[s]
- Total used size from partition: 88 %
- Free on this partition: 5 MByte[s]

At the bottom of the configuration area, there are "Clear" and "Set" buttons. Below the configuration area, there is a "Recording active" status indicator with a small icon of a camera.

Figure 39. Configuration Page for Properties Settings

This page lets you see and modify current settings for the partitions. You can change alarm recording options here. Also, it shows information about partition size and remaining recording time.

 **WARNING:** Any recordings on a partition will be lost if you change the settings.

Click the **Properties** tab to access this page.

Configuration Item	Default Setting	Description
Partition name	N/A	This field displays the name of the partition selected from the pull-down menu at the top of the screen.
Partition number	N/A	This field shows which of eight possible partitions is selected.
Type of recording	Linear mode	Use the pull-down menu to select either Linear or Ring mode as the type of recording. (In Ring mode, earlier video recordings already on the hard disk are overwritten with current recording when the recording capacity is used up. In Linear mode, recording ceases when the storage capacity of this partition is full until you delete previous recordings to release storage space.)
Video recording	high quality (CIF)	Use the pull-down menu to select from one of the available recording options (CIF, 2CIF, QCIF, DSL, ISDN [2B], ISDN [1B], MODEM, or GSM).
Number of alarms	1	Use the pull-down menu to select the number of alarms (0-126) that will be recorded. (For example, if you set 5, then only five alarms will be recorded.)
Alarm recording time	15 sec (pre-) 45 sec (post-)	Use the pull-down menus to set how long to record before and after an alarm is received (from 0 and seconds to 3 hours)
Alarm recording on	N/A	Check either Motion alarm or Alarm input to designate what condition should trigger alarm recording. (You must select one of these in order to use the Alarm Recording scheduler.)
Partition total size	N/A	This field shows the total size of the partition selected.
Remaining for recording	N/A	This field shows the approximate recording time remaining in the partition.
Free on this partition	N/A	This field shows the space remaining in the partition.
Used alarmtracks from partition	N/A	This bar shows how many tracks in the partition have been used for alarm recording. There is one alarm per track.
Used filetracks from partition	N/A	This bar shows how many tracks in the partition have been used for recording.
Total used size from partition	N/A	This bar shows the percentage of the partition that has been used for recording.

CONFIGURATION USING A TERMINAL PROGRAM

Using a terminal program (for example, the Windows application HyperTerminal) on a computer connected to the COM2: RS232 socket on the NET350's rear panel provides limited configuration and control capabilities.

Do the following:

1. Ensure that the PC's COM port is set up properly (default properties are 19200 baud, 8 bits, no parity, 1 stop bit, flow control none) and that the local terminal echo is disabled.
2. Isolate the NET350 from the network.
3. Connect the COM2: RS232 socket on the NET350 to an unused serial port on the PC (null modem required).
4. After the connection is made, you will be prompted for the case-sensitive user name. The factory default is **service**.
5. All commands consist of single characters you type inside the terminal window. Enter only one command at a time and do not terminate this input by pressing the Enter key. After entering a value (for example, an IP address), check the entered characters again and only then press Enter to transmit the values to the NET350.

The following section shows a typical session.

TYPICAL SESSION

The terminal program main menu appears in the terminal window as shown below.

```
'v' video
'i' IP
'r' RCP+
'? ' this menu
'q' exit/logout
```

NOTE: You cannot use backspace during a terminal session if you mistype a character, end your entry by pressing Enter and try again. If you see duplicate characters on any entry, the "local echo" feature of your PC's terminal program is not disabled.

If you are using the terminal to set up the unit's IP address, just type **i** and then **i** again. You are prompted to enter a new IP address. Do so and press Enter.

If you want to establish a live video connection to a remote unit, you have to specify the remote IP address by typing **r** and then entering the remote IP address.

To establish a connection, go to the main menu, then type **r**, then type **e**, and then select either video 1 or video 2. To disconnect, type **2** in the same menu.

TERMINAL PROGRAM TRANSMITTER MENU STRUCTURE

The following describes the terminal program transmitter menu structure. The menu items and commands are enclosed in single quotation marks. Do not enter the quotation marks. Information and current settings are displayed to the right of the commands. Refer to the *Command Reference* section for descriptions of the commands.

Main Menu

'v' video
'i' IP
'r' RCP+
'm' misc
'?' this menu
'q' exit/logout

v – Video Menu

'e' encoder settings
'a' adapt std res (e.g., CIF) to NTSC: 1
'x' leave this menu
'?' this menu

e – Encoder Submenu

'e' select encoder: 1
'>' start encoder: 1
'l' stop encoder
'p' parameter set: 1
'n' parameter set name: high quality (CIF)
'k' min frame dist [1]: 1
'r' encoder bitrate [kBit]: 5000
'Q' I quantizer: 8
'q' P quantizer: 8
'i' I frame distance: 0
'u' I update distance: 250
's' frame size (res): 3
'w' custom width: 432
'h' custom height: 288
'd' reset to default
'x' leave this menu
'?' this menu

a – Adapt Standard Resolutions submenu

Adapt standard resolutions (e.g., CIF) to NTSC? 0 = no, 1 = yes

i – IP Menu

An asterisk (*) means a reset of the NET350 after a change is necessary. Reboot by cycling the power.

'i' local IP (*): 172.16.0.96
's' local subnet mask (*): 255.255.0.0
'g' local gateway (*): 0.0.0.0
'r' remote IP: 172.16.0.99
Mac address: 00-07-5f-30-00-3c
'a' auto connect (off)
'p' ping remote IP (off)
'x' leave this menu
'?' this menu

r – RCP+ Menu

'e'	select video encoder number:	1
'c'	display connection list	
'1'	connect to alarm IP:	172.16.0.99
'2'	disconnect all connections	
'3'	G.711 audio:	On
'4'	join stream:	172.16.0.99
'x'	leave this menu	
'?'	this menu	

m – Misc Menu

'v'	get version info	
'x'	leave this menu	
'?'	this menu	

TERMINAL PROGRAM RECEIVER MENU STRUCTURE

The following describes the terminal program receiver menu structure. The menu items and commands are enclosed in single quotation marks. Do not enter the quotation marks. Information and current settings are displayed to the right of the commands. Refer to the *Command Reference* section for descriptions of the commands.

Main Menu

'i'	IP	
'r'	Rcp+	
'm'	misc	
'?'	this menu	
'q'	exit/logout	

i – IP Menu

An asterisk (*) means a reset of the NET350 after a change is necessary. Reboot by cycling the power.

'i'	local IP (*):	172.16.0.95
's'	local subnet mask (*):	255.255.0.0
'g'	local gateway (*):	0.0.0.0
'r'	remote IP:	0.0.0.0
	Mac address:	00-07-5f-30-00-32
'a'	auto connect (off)	
'p'	ping remote IP (off)	
'x'	leave this menu	
'?'	this menu	

r – RCP+ Menu

'e'	select video encoder number:	1
'c'	display connection list	
'1'	connect to alarm	IP: 0.0.0.0
'2'	disconnect all connections	
'3'	G.711 audio:	On
'4'	join stream:	0.0.0.0
'x'	leave this menu	
'?'	this menu	

m – Misc Menu

'v'	get version info	
'x'	leave this menu	
'?'	this menu	

COMMAND REFERENCE

The following table gives an overview of the available commands.

Table B. Terminal Command Reference

Cmd	Description
?	This command redisplay (refreshes) the current menu.
>	This command turns encoding of video back on.
1	Use this command to connect to the receiver in a box-to-box setup.
2	Use this command to sever all connections to the unit.
3	Use this command to toggle audio on/off to the receiver. The default is on.
4	(Receiver only.) Use this command to join the stream of video from the NET350 transmitter. It establishes a physical box-to-box connection.
a	(IP menu) Use this command to toggle auto-connect on/off. The default is off.
a	(Video menu) Enter 0 (no) or 1 (yes) to indicate whether to adapt standard resolutions to NTSC (for example, CIF to NTSC).
c	Use this command to display a list of physical network connections. This can be through Internet Explorer or a box-to-box connection.
d	This command returns the settings on this menu to factory defaults.
e	Use this command to select the video you wish to configure or for which you wish to see information. Enter 1 or 2. (Transmitter only.)
g	Use this command to enter a new gateway IP address. Type a new gateway address, and then press Enter.
h	This command lets you set custom resolution (height: 128 to 240).
i	(Encoder submenu) Use this command to change the size of the frames within the video stream.
i	(IP menu) Use this command to enter a new IP address that PelcoNet will be using on the network. Type the new IP address, and then press Enter.
k	Use this command to set minimum frame distance.
l	This command shuts off decoding of video from the NET350.
n	Use this command to name the encoder presets. Type in the name and press Enter. (Name appears in Internet Explorer.)
p	(Encoder submenu) Enter a number (1-8) that corresponds to a predefined profile. For example, 1 corresponds to "high quality (CIF)."
p	(IP menu) Use this command to see if a unit can be reached. This pings the IP set in the 'r' menu (remote IP). The unit will respond if it can be reached, or the ping command will time out if it cannot be reached.
q	Use this command to adjust the value between frame quality and data rate. Enter a value between 1 and 31. Value 1 has highest I-frame quality with a higher bandwidth while value 31 has lower quality and less bandwidth.
Q	Use this command to adjust the value between video quality and the image frame rate. Enter a value between 1 and 31. Value 1 has the highest quality with a lower video frame rate while value 31 is a maximum frame rate at lower quality.
r	(Encoder submenu) Use this command to designate the data rate. Enter the data rate figure.
r	(IP menu) Use this command to connect to a remote IP. Type the IP address, and then press Enter.
s	(Encoder submenu) Enter a number to designate the frame resolution. Enter 2 for QCIF, 3 for CIF, or 6 for 2CIF.
s	(IP menu) Use this command to enter a new subnet mask. Type the new subnet mask, and then press Enter.
u	Use this command to set the I-frame update distance.
v	Displays version information for the unit.
w	This command lets you set custom resolution (width: 176 to 704).
x	Exits this menu.

Operation

LIVE VIDEO AND SERVER PUSH VIDEO PAGES

The live video pages show a real-time picture of a camera view with update rates and image quality similar to a box-to-box configuration. It can be configured for bandwidth use and for various image quality settings. (Live video is accessible only through a NET350 transmitter and not through a NET350 receiver.) The Server Push pages show still pictures that are updated periodically, and image quality is fixed.

The five indicators in Table C are located at the top of the live video and live video control pages.

Table C. Live Video Page Indicators

Indicator	Description
MPEG-4	Indicates that live viewing is in MPEG-4 format.
M (motion detector)	When motion alarm is triggered, this indicator turns red while the alarm is activated.
V (video alarm)	When the video loss alarm is triggered, this indicator turns red until the video returns.
I (input activation)	When triggered, this indicator turns red. The name assigned to this trigger and its duration and how it reacts can be assigned on the Alarm page.
R (relay activation)	When triggered, this indicator turns red. The name assigned to this trigger and how it reacts can be assigned on the Relay page.



Figure 40. Live Video and Server Push Video Pages

1. To access the PelcoNet NET350 transmission system home page, you must first connect to the Internet/intranet network and open Internet Explorer (the browser).
2. Then, enter the default address (**10.0.0.1** for transmitters or **10.0.0.2** for receivers) in the address box. If this address has been changed, enter the application address. The home page appears.
3. Click either **Video 1** or **Video 2** or **Server Push** on the home page.

To exit any page, click an option at the top of the page.

The program displays dialog boxes when you try to view live video under any of the following conditions:

- With a browser other than Internet Explorer
- Without first installing ActiveX

- When your computer display is not set for 16- or 32-bit color

To change: right click the desktop, and then click **Properties**, the **Settings** tab, and select **High Color [16 bit]** or **True Color [32 bit]**. For NT, select **65536 Colors**.

NOTE: Do not change the video properties while viewing live video. You may get a gray background if you do.

- When Microsoft Virtual Machine is not enabled.

To enable: on the Tools menu select **Internet Options**, select the **Advanced** tab, locate **Microsoft VM**, checkmark **Java Console Enabled** and **JIT compiler for virtual machine enabled**. Reboot your PC.

With any of these conditions, you can only view the video as a series of still images.

DISPLAYING VIDEO ON A WEB BROWSER

The NET350T uses MPEG-4 for transmitting video across the network. This enables transmission to standard web browsers of either live video (Video 1 or 2 mode) or a stream of still images (Server Push mode).

- To activate the live video feature, click either **Video 1** or **Video 2** above the video window on the PelcoNet NET350 transmission system home page (refer to Figure 40). The unit transmits using MPEG-4 format for display in the browser.

To stop live video, click any other option at the top of the page.

- To activate the Server Push feature, click **Server Push** above the video window on the home page. The unit continuously grabs snapshots to be JPEG encoded, transferred, and displayed continuously by the browser.

To stop Server Push, click any other option at the top of the page.

The PelcoNet NET350 transmission system can display live video to an infinite number of users at a time (multicasting).

Server Push can support multiple users simultaneously on the same transmitter. Image quality is good with an update rate of one image about every 2 to 10 seconds depending on the number of users and available bandwidth.

Browsers that do not support live video technology can display an update still image or a stream of images in Server Push mode.



Figure 41. PelcoNet NET350 Home Page

USING THE AUDIO TRANSMISSION FEATURE OF A LIVE VIDEO PAGE

To transmit audio via microphone from your PC to the NET350T, do the following:

1. Connect a microphone that is compatible with your PC to your PC's "mic" input.
2. Connect a speaker to the NET350T's Audio I/O port.
3. While viewing live video, press the F12 key on the PC to send audio to the NET350T. Note that while holding down the F12 key, audio from the NET350T will not be heard (half duplex).

WEB BROWSER CONTROL PAGES

These pages let you control certain Pelco equipment at your computer through a NET350 transmitter (not through a NET350 receiver).

1. To access the PelcoNet NET350 transmission system home page, you must first connect to the Internet/intranet network and open Internet Explorer (the browser).
2. Then, enter the default address (**10.0.0.1** for transmitters or **10.0.0.2** for receivers) in the address box. If this address has been changed, enter the application address. The home page appears.
3. Click **Control** to access the Device Controls page.
4. The Device Controls page has underlined links to the control pages. To access, click one.

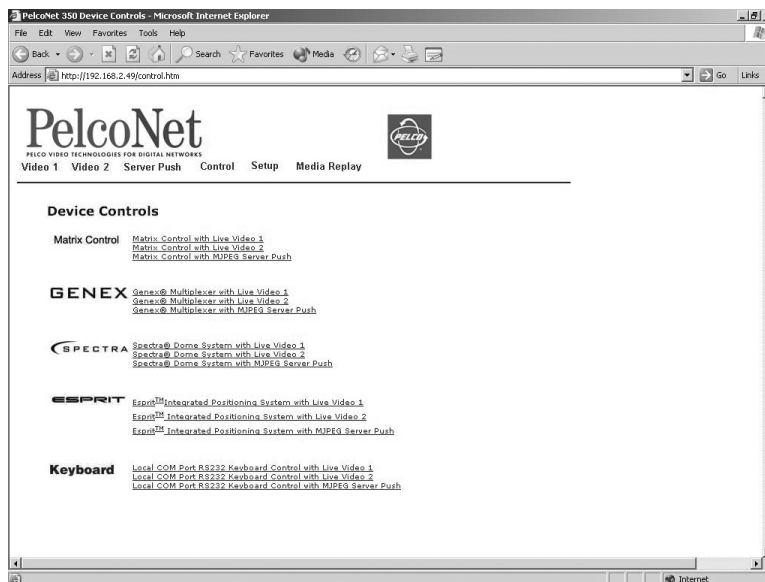

Figure 42. Device Controls Page

The live video control pages include representations of keys that let you control various functions (in addition to showing the camera display). Use the mouse pointer and click the left mouse button to enable options and operate controls on the screen. Click outside the options to disable a radio button or selection button.

Live video pages let you choose the size of the video viewing area. Click either **352x288** (small) or **704x576** (large) in the Resize Video field.

Live video pages also let you record and play back camera views on a PC's hard drive. Refer to the *Recording and Viewing the Display on a PC and the NET350* section for details.

Server push page displays are similar to live video page displays except the server push page lacks the live page indicators at the top of the page and the recording buttons below the picture.

MATRIX LIVE VIDEO/SERVER PUSH PAGE CONTENTS

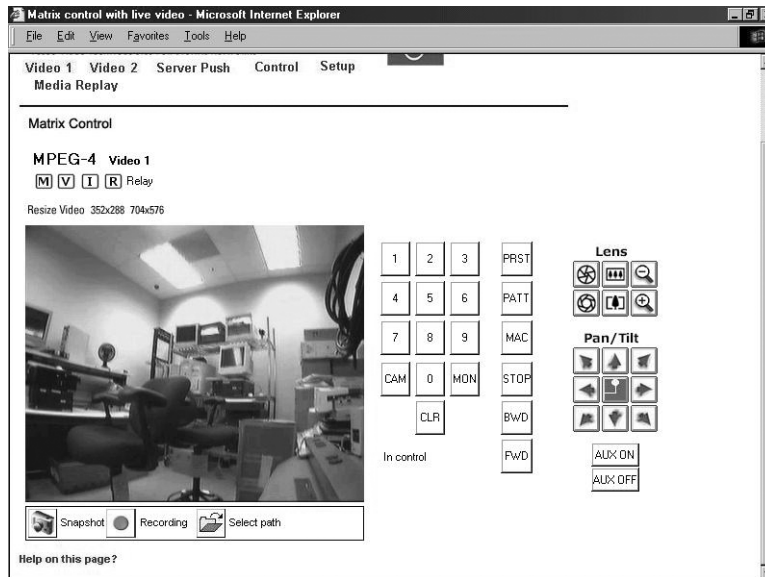

Figure 43. Matrix Control Page (Live Video Page Shown)

The Matrix Control pages contain the following:

- Live video indicators (live video page only)
- Ten numbered buttons
- CAM (camera) button to select a camera
- MON (monitor) button to select a monitor
- CLR (clear) button to cancel an entered number
- PRST (preset) button to select a preset
- PATT (pattern) button to select a pattern
- MAC (macro) button to select a group camera sequence (not supported for the CM6700)
- STOP button to halt a function
- BWD (backward) button to scroll through the cameras in reverse order
- FWD (forward) button to scroll through the cameras in forward order
- AUX ON button to activate an auxiliary
- AUX OFF button to deactivate an auxiliary
- ACK button to close a message when programming a pattern on the **CM6700 only**
- SET check box to use in programming presets and patterns

The following are arrayed under "Lens":

- Iris open and close buttons
- Focus far and near buttons
- Zoom out and in buttons

The following are arrayed under "Pan/Tilt":

- Eight direction arrow buttons
- Home button in the center to return the camera to its home position (preset 1)

"In Control" or "No Control" indicates whether you have control of the camera. Note that PTZ functions are temporarily disabled while recording live video. Recording control buttons are beneath the picture (live video page only).

On the Matrix live video control page, you can control the following:

- **Monitor:** To select a monitor, enter the monitor number and then click **MON**.
- **Camera:** To select a camera, enter the camera number (1-16) and then click **CAM**.

- **Presets:** To program a preset from the Matrix browser page: set the image using the arrow keys, click **SET**, enter a preset number, and then click **PRST**. To activate a preset, enter the preset number (1-66) and then click **PRST**. (You must click the **CLR** button before activating another preset.)
- **Patterns:** To program a pattern from the Matrix browser page: click **SET**, click **PATT**, run your pattern using the arrow keys, and then click **PATT** again when you are finished. (The CM6700 does not support programming of a pattern from the browser.) To run a pattern, click **PATT**. To halt, click a pan and tilt button, call a preset, or click **STOP**. (Clicking **STOP** will not halt a pattern on the CM6700 and CM6800.)

NOTE: For the CM6700 only, click the **ACK** button to close the message "Send Pattern End Command to Exit" when it appears.

- **Programming menus:** To access the programming menus, click **9, 5, SET**, and then **PRST**.
- **Macros:** To start a macro, enter **1** or **2** and click **MAC**. To stop a macro, select a camera or click a pan and tilt button.
- **Auxiliaries:** To turn on an auxiliary, enter the auxiliary number and then click **AUX ON**. To turn off, enter the auxiliary number and then click **AUX OFF**.

GENEX LIVE VIDEO/SERVER PUSH PAGE CONTENTS

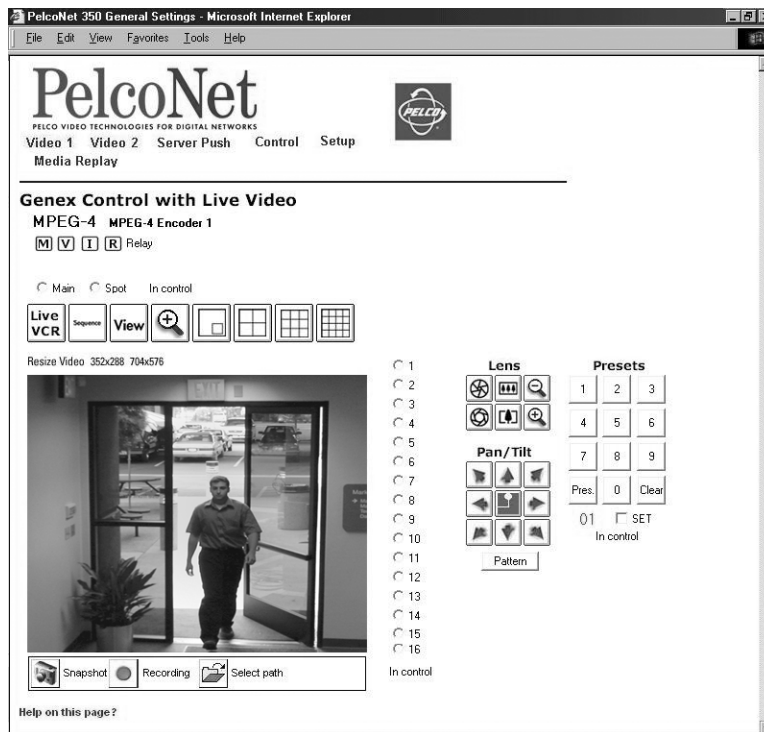

Figure 44. Genex Control Page (Live Video Page Shown)

The Genex pages contain the following across the top of the page:

- Live video indicators (live video page only)
- Main and Spot monitor selection radio buttons
- A LIVE/VCR button to toggle main monitor display between live input and playback from a VCR
- A Sequence button to activate a group camera sequence
- A View button to show in Live mode the multiplexed output from the VCR and in VCR mode to show the multiplexed input from the VCR
- A zoom button
- A picture-in-picture button
- Buttons for 4-, 9-, and 16-screen display

The following are arrayed down the right side of the page:

- Radio buttons for 16 cameras
- Iris open and close buttons
- Focus far and near buttons
- Zoom out and in buttons
- Eight direction arrow buttons with a home button in the center to return the camera to its home position (preset 1)
- Ten numbered buttons to use with the Pres and Pattern buttons to activate a preset and run patterns
- A SET check box to use in programming presets and patterns
- A Pattern button to run a pattern for each camera

“In Control” or “No Control” below the buttons indicates whether you have control of the camera. Recording control buttons are beneath the picture (live video page only).

On the Genex live control page, you can control the following:

- **Monitor:** To select a monitor, click either the **Main** or **Spot** radio button.
- **Camera:** To select a camera, click one of the 16 camera radio buttons.
- **Presets:** To program a preset from the Genex browser page: set the image using the arrow keys, click **SET**, enter a preset number, and then click **Pres**. To activate a preset, enter the preset number and press **Pres**. (You must click the **Clear** button before activating another preset.)
- **Patterns:** To program a pattern from the Genex browsers page: click **SET**, click **Pattern**, run your pattern using the arrow keys, and then click **Pattern** again when you are finished. To run a pattern, click **Pattern**. (You can run only the first programmed pattern.) To stop a pattern: click **96** and then click **Pres**.
- **Sequence:** To activate a group camera sequence, click **Sequence**.

SPECTRA LIVE VIDEO/SERVER PUSH PAGE CONTENTS



Figure 45. Spectra Control Page (Live Video Page Shown)

The Spectra page contains the following at the top of the page:

- Live video indicators (live video page only)

The following are arrayed down the right side under “Lens”:

- Iris open and close buttons
- Focus far and near buttons
- Zoom out and in buttons

The following are arrayed under "Pan/Tilt":

- Eight direction arrow buttons
- Home button in the center to return the camera to its home position (preset 1)

The following are arrayed under "Presets":

- Ten numbered preset buttons
- Pres (preset) button
- Clear button
- A SET check box

The following are arrayed under "Pattern":

- A Start pattern button
- A Stop pattern button

"In Control" or "No Control" indicates whether you have control of the camera. Recording control buttons are beneath the picture (live video page only).

On the Spectra live video control page, you can control the following:

- **Presets:** To program a preset from the Spectra browser page: set the image using the arrow keys, click **SET**, enter a preset number, and then click **Pres**. To activate a preset: enter a preset number and click the **Pres** button.
- **Patterns:** You can program and run only one pattern through PelcoNet. To program a pattern: click **SET**, click Start, run your pattern using the arrow keys, and then click **Stop**. To operate a pattern: click **Start** to begin the pattern and **Stop** to halt.
- **Programming menus:** To access the programming menus: enter **95**, click **SET**, and then **Pres**. Use the open iris icon to open menus and arrow keys to navigate and set options. Use the open iris icon in conjunction with the **Exit** option to move backward through menu layers and to exit programming mode.

NOTE: You can program presets and patterns for Spectra III either from inside the camera menu or through a controller. With Spectra II you can program presets and patterns through a controller or through the browser.

ESPRIT LIVE VIDEO/SERVER PUSH PAGE CONTENTS



Figure 46. Esprit Control Page (Live Video Page Shown)

The Esprit page contains the following at the top of the page:

- Live video indicators (live video page only)

The following are arrayed down the right side under “Lens”:

- Iris open and close buttons
- Focus far and near buttons
- Zoom out and in buttons

The following are arrayed under “Pan/Tilt”:

- Eight direction arrow buttons
- Home button in the center to return the camera to its home position (preset 1)

The following are arrayed under “Presets”:

- Ten numbered preset buttons
- Pres (preset) button
- Clear button
- A SET check box

The following are arrayed under “Pattern”:

- A Start pattern button
- A Stop pattern button
- A Wiper button

“In Control” or “No Control” indicates whether you have control of the camera. Recording controls buttons are beneath the picture (live video page only).

On the Esprit live video control page, you can control the following:

- **Presets:** To program a preset from the Esprit browser page: set the image using the arrow keys, click **SET**, enter a preset number, and then click **Pres**. To activate a preset: click a preset number button, and then click **Pres**. (You must click the **Clear** button before activating another preset.)
- **Patterns:** You can program and run only one pattern through PelcoNet. To program a pattern: click **SET**, click **Start**, run your pattern using the arrow keys, and then click **Stop**. To operate a pattern: click **Start** to begin the pattern and **Stop** to halt.
- **Programming menus:** To access the programming menus: enter **95** and click **SET**, and then **Pres**. Use the open iris icon to open menus and arrow keys to navigate and set options. Use the open iris icon in conjunction with the **Exit** option to move backward through menu layers and to exit programming mode.

KEYBOARD LIVE VIDEO/SERVER PUSH PAGE CONTENTS



Figure 47. Keyboard Control Page (Live Video Page Shown)

The Keyboard page lets you control a camera through a Pelco keyboard rather than through a PC's keyboard. The Keyboard page contains live video indicators (live video page only) at the top of the page. Recording control buttons are beneath the picture (live video page only). The hard disk icon (when showing) indicates that a compact flash drive is connected.

RECORDING AND VIEWING THE DISPLAY ON A PC AND THE NET350

Video 1 and 2 and live video control pages let you keep snapshots (still pictures) and record the camera video display on a PC's hard drive and play it back later. (You can also record snapshots from the Server Push pages.) The file is recorded on the hard drive of the PC on which you are viewing the picture. The controls are a row of buttons beneath the screen.

NOTE: When video files are saved, an extra file (.ind extension) is created that lets you see the video in Pelco's MPEG Viewer. If you delete this file, you cannot view the saved .mp4 file.

CHOOSING WHERE TO STORE THE FILE

The program automatically saves snapshots and video recording files at C:\ on the hard drive of the PC on which you are viewing the picture unless you tell it otherwise. If you want to store files in a different location on the PC, you need to first specify that location. To do so:

1. On the Home page, click either **Control** (and then click one of the underlined links to a live video control page) or **Video 1** or **Video 2**.
2. Click the **Select path** icon (open folder) beneath the picture. (Click the icon just once. Double-clicking may cause display problems with the select path window.)
3. The program opens the "Path for saving MPEG/JPEG files" screen. Do not specify a file name (leave blank), just navigate to the location where you want the file stored and then click the **Save** button.

The file of any snapshot or video you record will be saved to that location.

RECORDING A SNAPSHOT FROM VIDEO

You can record a snapshot from the Video 1 or 2 pages or from the live video and Server Push, Matrix, Genex, Spectra, and Esprit control pages. The file is recorded on the PC on which you are viewing the picture. To do so:

1. On the Home page, click either **Control** (and then click one of the underlined links to a live video control page) or **Video 1** or **Video 2** or **Server Push**.
2. Position the camera as desired (if it has PTZ capability).
3. Click the **Snapshot** icon (camera) to record a still picture. The snapshot is saved on the PC's hard drive with a .jpg extension.

VIEWING A SNAPSHOT

You can view a snapshot by double-clicking the desired file (.jpg extension) in Windows Explorer.

RECORDING THE VIDEO DISPLAY ONTO THE PC

You can record the camera display from the Video 1 or 2 pages or from the live video Matrix, Genex, Spectra, and Esprit control pages. The file is recorded on the PC on which you are viewing the picture. To do so:

1. On the Home page, click either **Control** (and then click one of the underline links to a live video control page) or **Video 1** or **Video 2**.
2. Position the camera as desired (if it has PTZ capability).
3. Click the **Recording** icon (red dot button) to begin recording. The button flashes while recording is happening.
4. Click the **Recording** button again to stop recording. The recording is saved on the PC's hard drive with an .mp4 extension.

RECORDING THE VIDEO DISPLAY THROUGH COMPACTFLASH

Instead of recording video sequences onto your computer's hard drive, you can choose to record them locally onto the NET350. For local recording through the CompactFlash interface on the NET350's front panel, you can use standard CompactFlash cards or miniature disk drives with a capacity of up to one GB. Video sequences are recorded in MPEG format.

NOTE: Remember, once you click the Start button to activate time or alarm scheduling, you cannot make changes or view other partitions until you stop the scheduler with the Stop button.

To record onto the NET350, you must first set up the unit for recording. To do so:

1. Click **Media Recording** on the Setup screen.
2. Storage can be allocated to more than one partition. If desired, click the **Enter partition settings!** button to access a screen that shows information about existing partitions. You can also delete partitions or access a wizard to guide you through adding partitions. When you finish, click the **Back to HD Scheduler page!** button.
3. If desired, click the **Properties** tab to access a screen where you can designate what properties you want associated with a partition. Refer to the *Configuration Pages for Media Recording* and *Configuration Page for Properties* sections. Click **Set** when finished.
4. If desired, click the **Time recording** tab to access a screen where you can set the times you want recording to occur. Refer to the *Configuration Pages for Media Recording* and *Configuration Page for Time Recording* sections.
 - Clicking a day button selects the entire row; clicking a time button selects an entire column. Clicking **Select all** picks all days and times. Or select a specific day and time by holding and dragging the mouse button.
 - Deselect by right clicking the mouse button on the selection. Deselect all with the **Clear** button.
 - Click **Set**, and then **Start** when finished.
5. If desired, click the **Alarm recording** tab to access a screen where you can set the times you want alarm recording to be active. Refer to the *Configuration Pages for Media Recording* and *Configuration Page for Alarm Recording* sections.

Selection and deselection work just as on the Time Recording screen described above. Click **Set**, and then **Start** when finished.

VIEWING THE VIDEO DISPLAY

The video file is identified by date and time. View the video display using the MPEGViewer program included on the PelcoNet Resource CD. Do the following:

1. Locate the **MPEGViewer.exe** file (either on the resource CD or the PC) or MPEG Viewer shortcut on the desktop if you used the installation program on the CD. Double-click the file. The viewer opens.

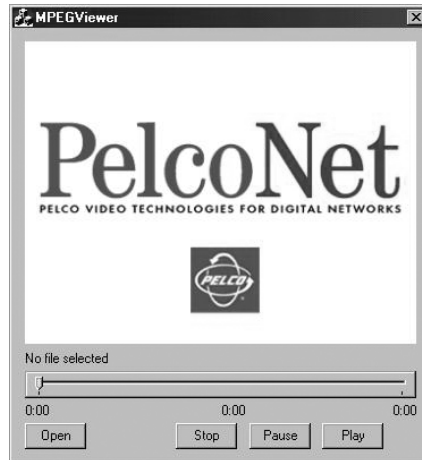

Figure 48. Viewer Screen

2. Click the **Open** button. A browse dialog box opens. Navigate to the recorded file (.mp4 extension) you want to view. Click the file to highlight it, and then click **Open**.
3. Click **Play** on the viewer to begin playback. The start and end locations are shown below the slide control. A counter marks your location in the file.
4. Use the **Pause** button to temporarily halt playback. You can change your location in the file by moving the pointer on the slide control. Click **Play** to resume playback.
5. Click **Stop** to halt playback.

NOTE: When video files are saved, an extra file (.ind extension) is created that lets you see the video in Pelco's MPEG Viewer. If you delete this file, you cannot view the saved .mp4 file.

MEDIA PLAYBACK SCREEN

Use this screen to view files recorded onto the unit's CompactFlash card, to record a snapshot, or to back up the recorded file onto your computer's hard drive.

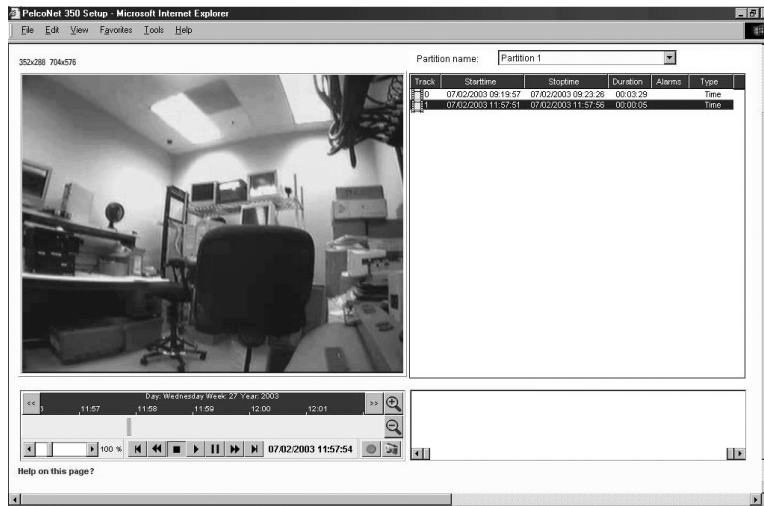

Figure 49. Media Playback Screen

VIEWING A FILE

To view a file:

1. Click **Media Replay** on the home page, live video page, server push page, or any control page. The Media Playback screen appears.
2. Use the pull-down menu to choose the partition from which you want to view a file. A list of files in the partition will be displayed. For each file you will see the order of recording, start/stop times, duration, and the number and type of alarms recorded.
3. Click the desired file. Playback begins in the viewing window automatically. You control the playback as follows:

- a. Below the window is a blue date/time video bar divided into increments. You can change the graduation by clicking the zoom in and zoom out magnifying glass icons. Select between intervals of three days, one day, two hours, five minutes, or one minute.

The indicator below the lavender bar shows the date and exact time.

A yellow slider shows your position in the displayed file. (You may have to click in the lavender bar to display the yellow slider.) Use the left and right arrow buttons on the blue bar to select the time in the file you want to see. Or you can move the blue bar left or right with the mouse button held down.

- b. You can pick another file for playback by clicking the corresponding time mark in the blue bar. The green border in the lavender bar signifies the active file. You can also start playback by positioning the mouse on the yellow slider, and then holding down the mouse button while moving the slider to the time you want.
 - c. Use the arrow buttons on the scale at the bottom of the screen to control the playback speed (100% is regular speed; lower values are slower while higher values are faster).
 - d. Red strips on the video bar indicate alarm activation.
4. Use the following buttons to further control playback:



These buttons jump the display to the next track or to the previous track.



This button plays the recording.



This button stops the playback.



These buttons move the display backward and forward while the display is paused.



This button pauses the playback.

BACKING UP A FILE ONTO A COMPUTER

You can also save video recordings that are on the NET350 directly to your computer's hard drive as backup. To do so:

1. Start playing back the file you want to back up in whole or in parts (refer to the *Viewing a File* section).
2. Click the red circle icon to immediately start recording onto the PC's hard drive. The circle blinks slowly to indicate recording has started.
3. Click the red circle icon again to stop recording.

You can repeat this procedure several times within a file to back up sections out of a long file.

RECORDING A SNAPSHOT FROM A FILE

You can record onto your computer's hard drive an individual frame (snapshot) from a file being played back. Do the following

1. Start playing back the file from which you want to take a snapshot (refer to the *Viewing a File* section).
2. Click the camera icon to store a snapshot. Snapshots are immediately displayed in the window on the right.
3. If a snapshot does not appear, go to the live page, click the select path icon, and then enter a new path where the snapshot will be saved. Repeat steps 1 and 2.

Software Upload

Units have flash EPROMs for software upgrades in the field. These upgrades can be done directly from the web browser. To do so:

1. Obtain the latest PelcoNet NET350 transmission system software from Pelco (<http://www.pelco.com>).
2. Use the browser to select the General Settings configuration page of your unit.
3. Use the **Browse** button in the **Software upload** field to select the correct new firmware file.
4. Click the **Upload** button. The **Upload progress** field shows how the upload is proceeding.

After about 30 seconds you should get a feedback message from the connected unit. The message "Upload Complete – WAIT" confirms the correct upload of the new firmware, which is now being installed. If you try to upload an invalid firmware file, you will get the message "Upload Failed."



WARNING: Do not disconnect power to the unit for any reason while firmware is being installed. Disrupting the cycle will damage the flash EPROM. If this occurs, you will have to return the unit for repair.

The unit automatically restarts when a successful upload is completed.

However, if the LED flashes green/red alternately on conclusion, the upload has been unsuccessful and must be restarted. To do so: in the browser's address field after the unit's IP address, enter **/main.htm**. For example, 192.168.0.12/**main.htm**. Restart the upload process.

5. If you revisit the General Settings configuration page after the firmware is uploaded successfully, you will see the message "New Firmware Installed."

Resetting the NET350

- **Hard reset:** Use a strong, thin item like a piece of wire to press the hard reset button on the front panel (refer to Figure 1) for three seconds. The unit will then reset.
- **Soft reset:** Type a forward slash (/) and **reset** at the end of the unit's address in the Internet Explorer browser address window, and then press **Enter**. The unit then displays the message "Bye Bye Going to reset."

Troubleshooting

If the following instructions fail to solve your problem, contact Pelco Technical Support at 1-800-289-9100 for help. You should have the serial number from the bottom of the unit and the firmware version ready in case they are needed.

Do not try to repair a unit yourself. Opening it immediately voids any warranty. Leave maintenance and repairs to qualified technical personnel. Swap a defective unit with a replacement unit and return the defective one for repair.

LEDS

The NET350 has several LEDs that indicate the operating status and possible faults.

Table D. LED Definitions

LED	Indication	Meaning
Power	Not lit	Device is switched off.
	Lit green	Device is switched on.
	Flashing green	Device is transmitting/receiving video/audio
	Lit red (temporary)	Device is starting.
	Lit red (permanent)	Device is out of order.
	Flashing green/red	Upload failed.
I	Lit red	Alarm input is activated.
	Not lit	Alarm input is inactive.
O	Lit green	Relay is switched.
	Not lit	Relay is inactive (resting state)
L	Lit green	Physical connection to the network is established.
	Not lit	There is no network connection.
T	Flashing yellow	Data is being transmitted via the network.
	Not lit	There is no data transmission.

TERMINAL PROGRAM

If the terminal program fails to connect to the unit's terminal port, check the following:

- Is the right COM port interface on the PC selected for the terminal program, and are the settings correct? Is the cable connected to COM 1 and **not** COM 2 on the PelcoNet unit? Program default settings are 19200kb/s, 8 data bits, no parity, 1 stop bit (8N1) for the terminal program.
- If the data exchange between the terminal program and the system still does not work, check the serial cable. Does the system answer when you press Enter on your keyboard?
- Disable the local echo if you see duplicate characters on your screen.

TROUBLESHOOTING A TCP/IP NETWORK USING A PING UTILITY

(Enter the appropriate information where indicated by the quotation marks. Do not enter the quotation marks.)

To see if a unit in your network can be reached, try to ping your unit by typing the following command in a DOS window:

```
c:\ping 'unit IP address'
```

If it is reached, there will be a response like the following:

```
Reply from <IP address>: bytes=32 time=NN ms TTL=xxx
```

If the LAN is malfunctioning, the ping command will time out. If so, you could have one of the following problems:

- Wrong physical connections. Make sure the LAN link LED is on.
- Wrong network connection. Verify the IP address is entered correctly and that subnet mask and gateway address are set properly.

Otherwise, ask your network administrator.

TROUBLESHOOTING CONNECTION PROBLEMS

If you fail to connect to a system from a NET350 receiver, check the following to pinpoint the problem:

- Do not connect two units of the same type (for example, receiver to receiver).
- Make sure network connectivity is available (for example, by using the ping command as described previously).
- Does the power LED flash?

If flashing, the units are connected. Verify how much bandwidth your connection has available and ensure the bandwidth specified in the Datarate field on the MPEG-4 Video Settings page does not exceed the available bandwidth.

If the power LED does not flash, verify that the Live Video Auto-Connect feature is set up correctly. Also, set the Video/Audio Transmission field on the Network Settings page to "TCP (port 80)."

TROUBLESHOOTING THE VIDEO CONNECTION

If no video or a distorted video image is displayed at the receiver during a connection to a transmitter:

- Make sure to use the right unit for your application: a camera can only be connected to a transmitter, never to a receiver.
- Make sure the video input on the transmitter is properly terminated.
- Make sure the camera is switched on and the coaxial cable is connected to the transmitter.
- Check the camera cable and connect a video monitor to the camera to check that the camera is functioning correctly.
- Make sure the monitor is switched on and the coaxial cable is connected to the NET350R receiver.
- Check the monitor cable and the selection of the monitor channel if the monitor features more than one video channel.
- **(NET350R unit only.)** Make sure the Output Standard field on the Video Decoder Settings page is set for the TV signal used in your region (NTSC or PAL). Restart the receiver if you have to change this field.

Specifications

NETWORK PROTOCOL AND STANDARDS COMPATIBILITY

Network Protocols	RTP, RTCP, UDP, TCP, IP, HTTP, SNMP, IGMP, ICMP, ARP
Video Coding	MPEG-4 (MJPEG in Server Push only)
Video Frame Rate	Up to 30 images/second

INTERFACE

Video Input or Output	1, BNC, PAL/NTSC, 75 ohms, 1 Vp-p
Audio Input/Output	3.5 mm stereo jack ring/tip contact
LAN Interface	Ethernet 10/100BASE-T autosensing, RJ-45
LAN Data Rate	9.6 Kbps to 5.0 Mbps
Data Interfaces	1 RS-232/RS-422/RS-485, bidirectional (9-pin, D-sub) and 1 RS-232 (9-pin, D-sub)
Alarm Input	1 terminal, 30 VDC maximum
Alarm Output	1 terminal, 30 VDC, 1 A

VIDEO

Video Standards	PAL, NTSC
Video Image Size	
PAL	4 CIF 704 x 576 pixels 2 CIF 704 x 288 pixels CIF 352 x 288 pixels
NTSC	4 SIF 704 x 480 pixels 2 SIF 704 x 240 pixels SIF 352 x 240 pixels

AUDIO

Output	
Physical Connection	3.5 mm stereo jack tip contact
Maximum Output Voltage	2.5 Vp-p
Maximum Output Power RMS	60 mW
Output Impedance	8, 16, 32 ohms
Input	
Physical Connection	3.5 mm stereo jack ring contact
Input Voltage	1 Vp-p (line level)
Input Impedance	50 kohm
Input Frequency Range	300 Hz - 10 kHz
Audio Distortion	<1%
Audio Signal-to-Noise Ratio	>50 dB (maximum)

POWER

Type	Plug power adapter
Operating Voltage	12-24 VDC, power supply included
Power Consumption	Approximately 10 W

MISCELLANEOUS

LED Displays	5 LEDs (alarm, relay, connection, data, power)
--------------	--

ENVIRONMENTAL

Operating Temperature	32° to 122°F (0° to 50°C)
Operating Humidity	80% maximum relative humidity, noncondensing
Storage Temperature	-4° to 140°F (-20° to 60°C)
Storage Humidity	95% maximum relative humidity, noncondensing

GENERAL

Dimensions	5.6 (W) x 1.3 (H) x 5.3 (D) inches (14.3 x 3.3 x 13.5 cm)
Unit Weight	Approximately 0.9 lb (0.4 kg) without power supply

Glossary

10BASE-T	IEEE 802.3 specification for 10 Mbs Ethernet
ARP	Address Resolution Protocol
Baud	Rate Data transmission rate
bps	Bits per second, the actual data rate
Cat5	Cable Type of cable used on a LAN to connect computers, printers, and transmitters and receivers to a hub on the network
CIF	Common Intermediate Format; video format with 352 x 288 pixels
Default Gateway	The router's IP address (for example, 192.168.0.1)
DHCP	Dynamic Host Configuration Protocol
DNS	Domain Name Service
FTP	File Transfer Protocol
Full Duplex	Simultaneous data transmission in both directions
G.711, G.728	Standard audio coding algorithms defined by ITU-T
H.224	Standardized protocol for data communication and remote control
H.261	Standard motion video coding algorithm defined by ITU-T
H.323	Standard for M-JPEG video and audio compression defined by ITU-T
HTML	Hypertext Markup Language
HTTP	Hypertext Transfer Protocol
Hub	A device on the network that connects multiple computers together to form a LAN
ICMP	Internet Control Message Protocol
ID	Identification: machine readable number or name
IGMP	Internet Group Management Protocol
IEEE	Institute of Electrical and Electronics Engineers
Internet Protocol	The main protocol used on the Internet. Forms in conjunction with the Transfer Control Protocol (TCP) the TCP/IP protocol suite.
IP	See Internet Protocol
IP Address	A unique four-byte number that identifies each unit on the Internet or network. Usually written in dotted decimal notation with periods separating the bytes. This address is required to communicate on the network (for example, 192.168.0.100)
ISDN	Integrated Services Digital Network
ISP	Internet Service Provider
JPEG	Joint Photographic Expert Group (procedure to encode still images)
Kbps	Kilobits per second; the actual data rate
LAN	Local Area Network. Multiple computers linked together into a network to share information within a limited geographic area (such as a building or a campus) controlled by a network operating system and using a transport protocol.
MAC Address	Media Access Control/hardware address

Mbps	Megabits per second; the actual data rate
MPEG-4	Used for transmission of audiovisual data with very low transfer rates (for example, via Internet); further development of MPEG-2 (enhanced video compression standard)
NAT	Network Address Translator. A proposal for IP address for re-use where the local IP address is mapped to a globally unique address
Network address Translator	A proposal for IP address re-use where the local IP address is mapped to a globally unique address
Parameter	Values used for the configuration of the network system
Picture	A video picture that has been digitized at a particular resolution
PPP	Point-To-Point Protocol. A protocol allowing a computer using TCP/IP to connect directly to the Internet
Router	A physical device that connects multiple LANs; a router knows where to direct a given packet of data
QCIF	Quarter CIF, video format with 176 x 144 pixels
Server Push	A continuous stream sent from the transmitter to the web browser
Subnet Mask	A mask that explains which part of an IP address is the network address and which part composes the host address; it is usually expressed in dotted-decimal notation (for example, 255.255.255.192)
TCP	Transfer Control Protocol
UDP	User Datagram Protocol
URL	Uniform Resource Locator
UTP	Unshielded Twisted Pair
WAN	Wide Area Network. Multiple LANs connected together, usually over a great distance.

Appendix A — Connecting PelcoNet to Various Components

Some of the connection examples that follow require a DB9 cable. Refer to the following figure when one is needed.

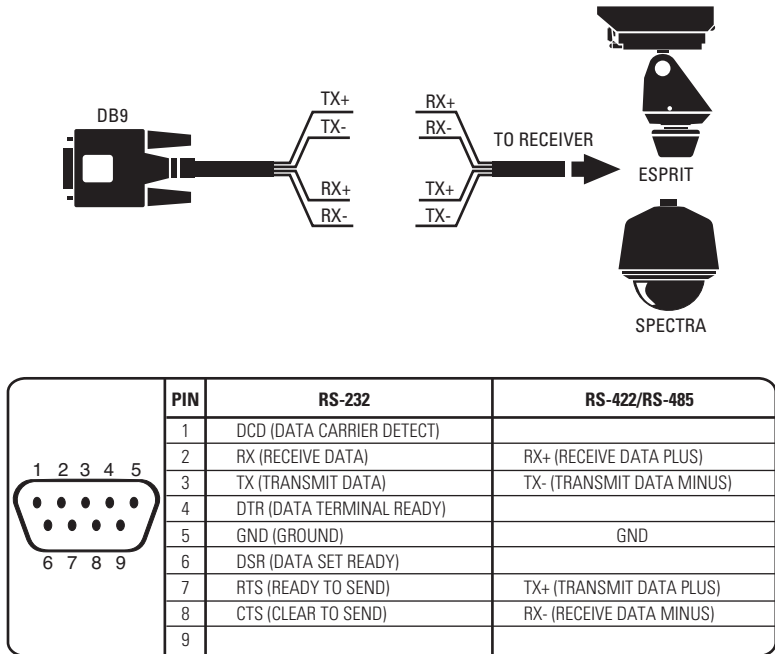

Figure 50. DB9 Cable Wire Splicing

CONNECTING PELCONET TO VARIOUS COMPONENTS WITH ASSORTED KEYBOARDS

CONNECTION SCENARIO 1 – USING A KBD300A IN DIRECT MODE

Refer to Figure 51 and the instructions that follow.

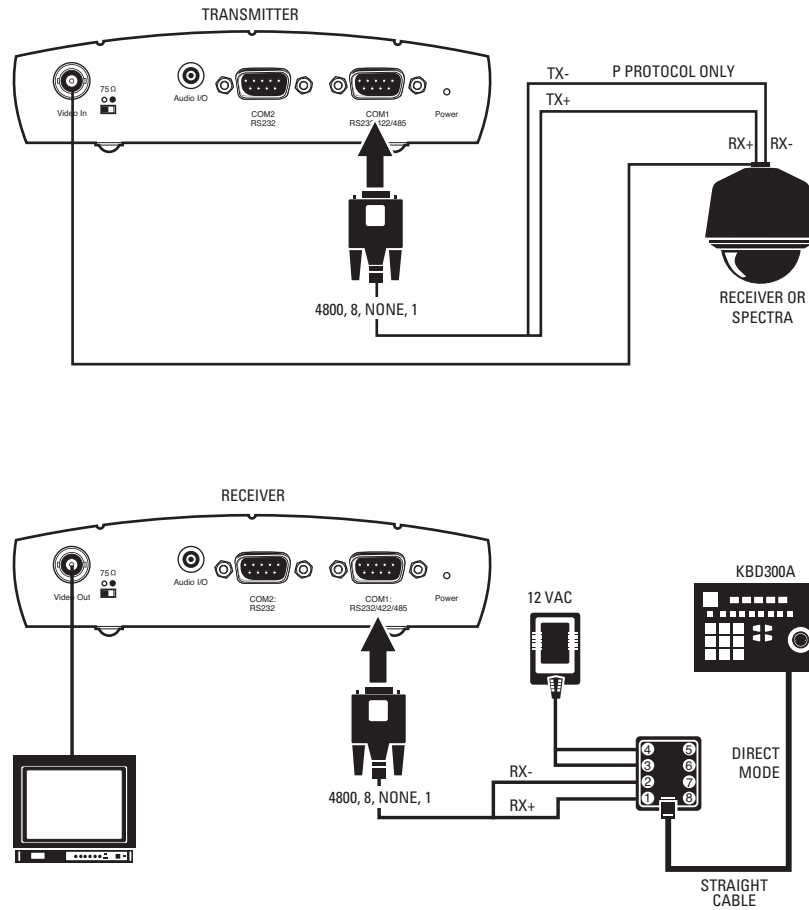

Figure 51. KBD300A (Direct Mode) Connected to a Receiver or Spectra Dome System

1. Connect a DB9 cable to the COM1 port on the back of the NET350 receiver. (In the Interface Mode field on the configuration page for the COM1 interface settings, select RS422/485.) The data format should be 4800 baud, 8 data bits, no parity, and 1 stop bit.
2. Connect RX- on the DB9 cable to terminal 2 on the wall block. Connect RX+ on the DB9 cable to terminal 1 on the wall block.
3. Connect a 12 VAC power supply to terminals 3 and 4 on the wall block.
4. Set DIP switch 6 on the KBD300A to ON to enable turbo pan operation or OFF to disable that feature. The KBD300A will recognize Direct Mode automatically.
5. Connect the wall block to the KBD300A with an RJ-45 straight cable.
6. Connect the monitor.
7. Refer to Figure 50 and Figure 51. Splice the supplied DB9 cable into the Spectra/Esprit or receiver cable. Use P protocol only.
8. Plug the DB9 cable into the COM1 port on the transmitter. (In the Interface Mode field, select RS-422/485.) The data format should be 4800, 8, no parity, 1.
9. Connect the camera's video to the transmitter.

CONNECTION SCENARIO 2 – USING A KBD4000 FOR MULTIPLEXER CONTROL

Refer to Figure 52 and the instructions that follow.

NOTE: If you set all your cameras to Standard Coaxitron for better control on the browser, you will lose most of the KBD4000 keyboard control functions. If you set your cameras to Extended Coaxitron, you will have all the keyboard functions but the PTZ functions on the NET350 will be very slow.

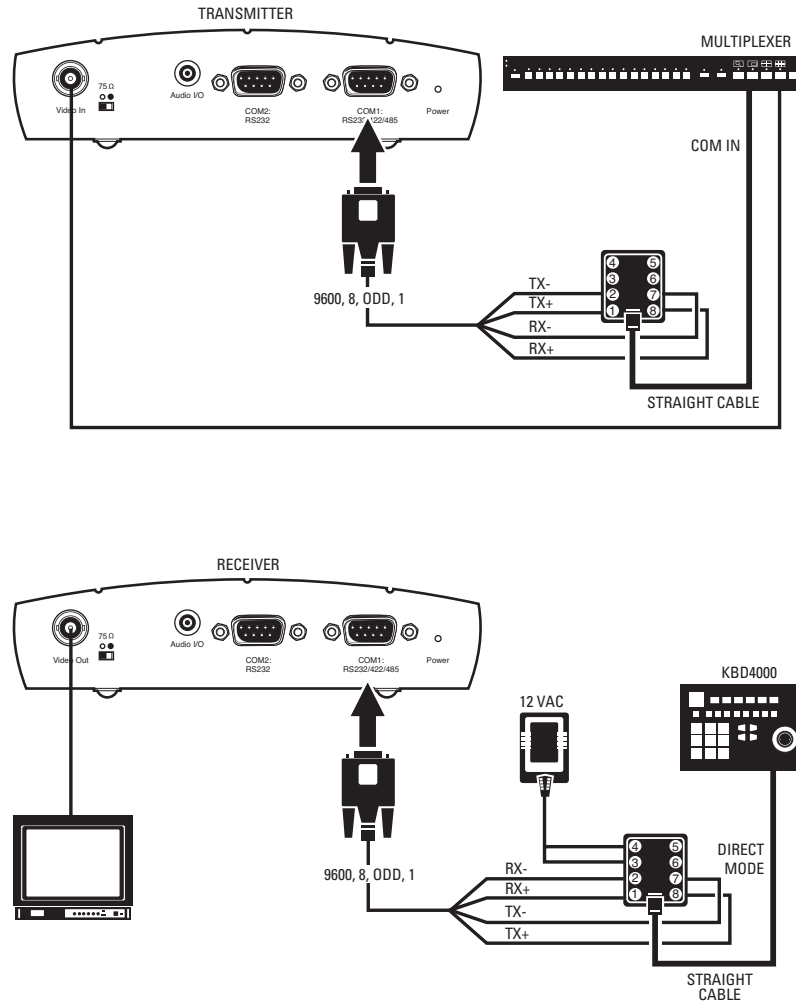

Figure 52. KBD4000 Connected to a Multiplexer

1. Connect a DB9 cable to the COM1 port on the back of the NET350 receiver. (In the Interface Mode field on the configuration page for the COM1 interface settings, select 232.) The data format should be 9600 baud, 8 data bits, odd parity, and 1 stop bit.
2. On the receiver side, connect TX- on the DB9 cable to terminal 7 on the wall block. Connect TX+ on the DB9 cable to terminal 8 on the wall block. Connect RX- on the DB9 cable to terminal 2 on the wall block. Connect RX+ on the DB9 cable to terminal 1 on the wall block.
3. Connect a 12 VAC power supply to terminals 3 and 4 on the wall block.
4. Connect the wall block to the KBD4000 with an RJ-45 straight cable. (Note that DIP switches 4 and 8 on the KBD4000 must be set ON.)
5. Connect the monitor.
6. Refer to Figure 50 and Figure 52. Splice the supplied DB9 cable into the multiplexer wall block. Connect TX- from the NET350 transmitter to terminal 2 on the wall block, TX+ to terminal 1, RX- to terminal 7, and RX+ to terminal 8.
7. Plug the DB9 cable into the COM1 port on the transmitter. (In the Interface Mode field, select RS-422/485.) The data format must be 9600, 8, odd, 1.
8. Connect the wall block to COM IN on the multiplexer with an RJ-45 straight cable.
9. Connect MAIN video output from the multiplexer to the transmitter.

CONNECTION SCENARIO 3 – USING A CM9760-KBD

Refer to Figure 53 and the instructions that follow.

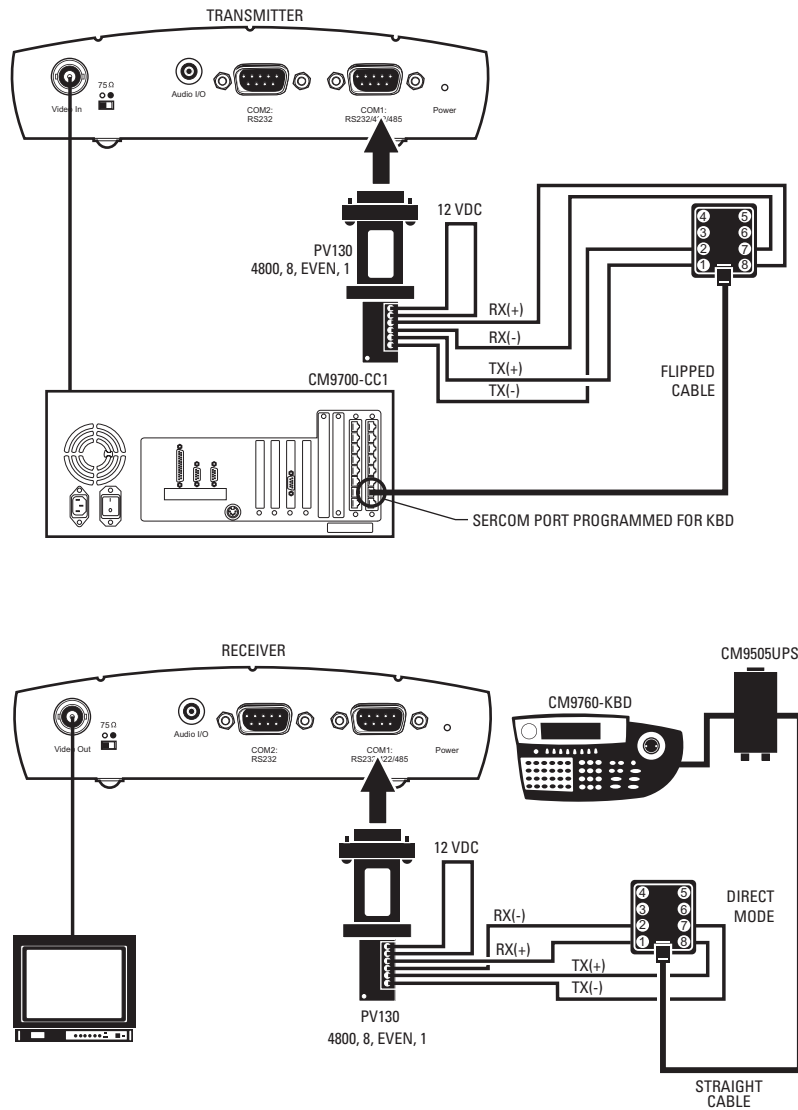

Figure 53. CM9760-KBD Connected to a CM9700-CC1 Controller

1. Connect a DB9 cable to the COM1 port on the back of the NET350 receiver. (In the Interface Mode field on the configuration page for the COM1 interface settings, select RS-232.) The data format must be 4800baud, 8 data bits, even parity, and 1 stop bit.
2. On the receiver side, connect TX- on the DB9 cable to terminal 7 on the wall block. Connect TX+ on the DB9 cable to terminal 8 on the wall block. Connect RX- on the DB9 cable to terminal 2 on the wall block. Connect RX+ on the DB9 cable to terminal 1 on the wall block.
3. Connect an RJ-45 straight cable from the wall block to the power pack.
4. Connect an RJ-45 straight cable from the keyboard input connector on the power pack to COM 1 on the keyboard.
5. Connect the monitor.
6. Refer to Figure 50 and Figure 53. Splice the supplied DB9 cable into the CM9760-CC1 wall block. Connect TX- from the NET350 transmitter to terminal 2 on the wall block, TX+ to terminal 1, RX- to terminal 7, and RX+ to terminal 8.
7. Plug the DB9 cable into the COM1 port on the transmitter. (In the Interface Mode field, select RS-232.) The data format must be 4800, 8, even, 1.
8. Connect an RJ-45 flipped cable from the wall block to Sercom port 5 on the CC1's rear panel.

- Connect one of the three monitor outputs on the rear of the controller to the transmitter.

CONNECTING A LOCAL KEYBOARD TO A PC

Refer to Figure 54. This configuration lets an operator control a camera or other external device through a Pelco keyboard attached to a local PC. (The KBD200A is shown as an example.)

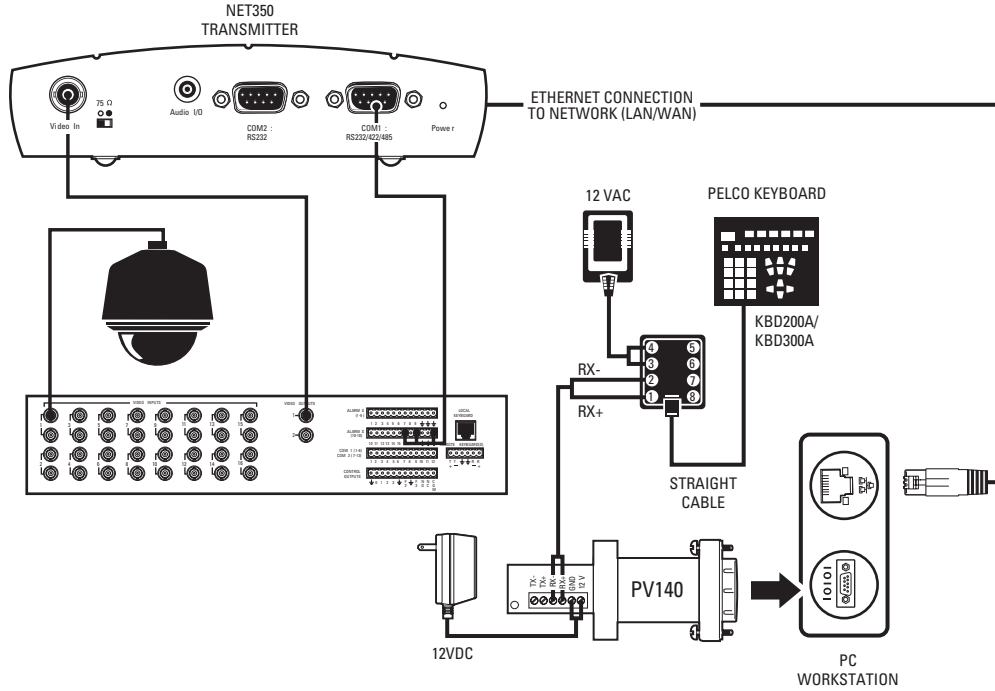

Figure 54. Connecting a Local Keyboard to a PC

CONNECTING PELCONET COM 1 RS-232 PORT TO THE GENEX MULTIPLEXER COM OUT PORT

Refer to Figure 55 and the instructions that follow.

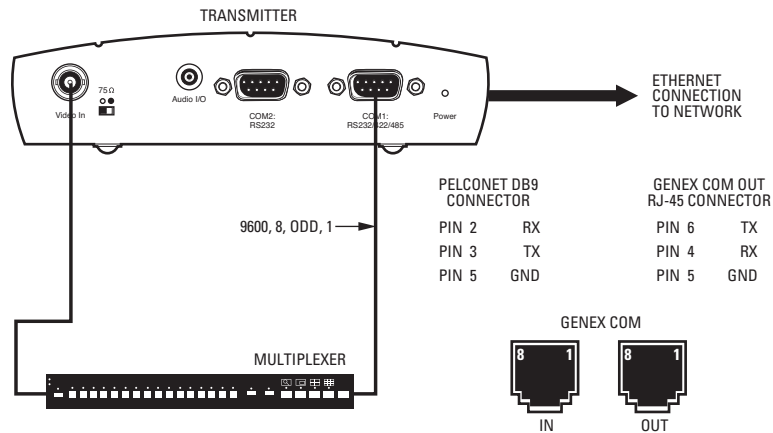

Figure 55. Connecting PelcoNet to Genex Using the COM 1 RS-232 Port

- Verify that the multiplexer has Version 4.1 or higher software for Genex units manufactured before November 22, 2002 or Version 1.12 or higher for units manufactured on or after that date. (The version numbering was restarted in 2003, which is why newer units have a smaller version number. The version number flashes on the monitor when power is applied to the multiplexer.)
- Set the NET350 COM1 data port to **Transparent, 9600 baud, 8 data bits, none** (for parity), **1 stop bit**, and **off** if it is not so set already. (In the Interface Mode field on the configuration page for the COM1 interface settings, select RS-232.)

3. Create a cable using the diagram in Figure 50.
4. Attach the cable's DB9 connector end to PelcoNet's COM1 port. Connect the cable's RJ-45 connector end to COM out on the back of the multiplexer.
5. Connect the MAIN video output from the multiplexer to the NET350 transmitter.
6. Connect PelcoNet's Ethernet port to the network using a Cat5 Ethernet patch cable.

CONNECTING PELCONET TO A CM6700 AND KBD200A FOR REMOTE ASCII CONTROL

Refer to Figure 56. This configuration lets an operator view and control cameras with a remote KBD200A keyboard.

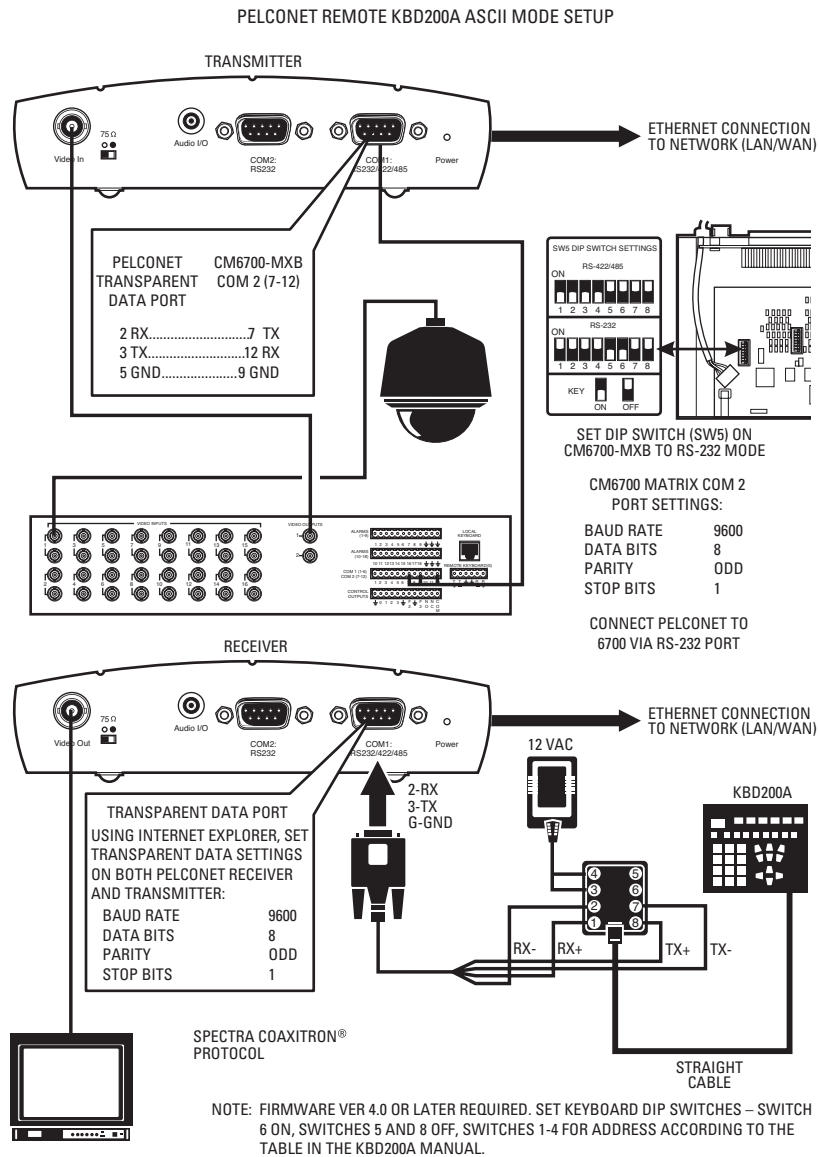

Figure 56. Using PelcoNet with CM6700 and KBD200A to Provide Remote Control

CONNECTING PELCONET TO A CM6700 ASCII PORT

Refer to Figure 57. This configuration lets an operator view and control cameras from a PC using a web browser. (The operator's PC is not shown on the diagram.)

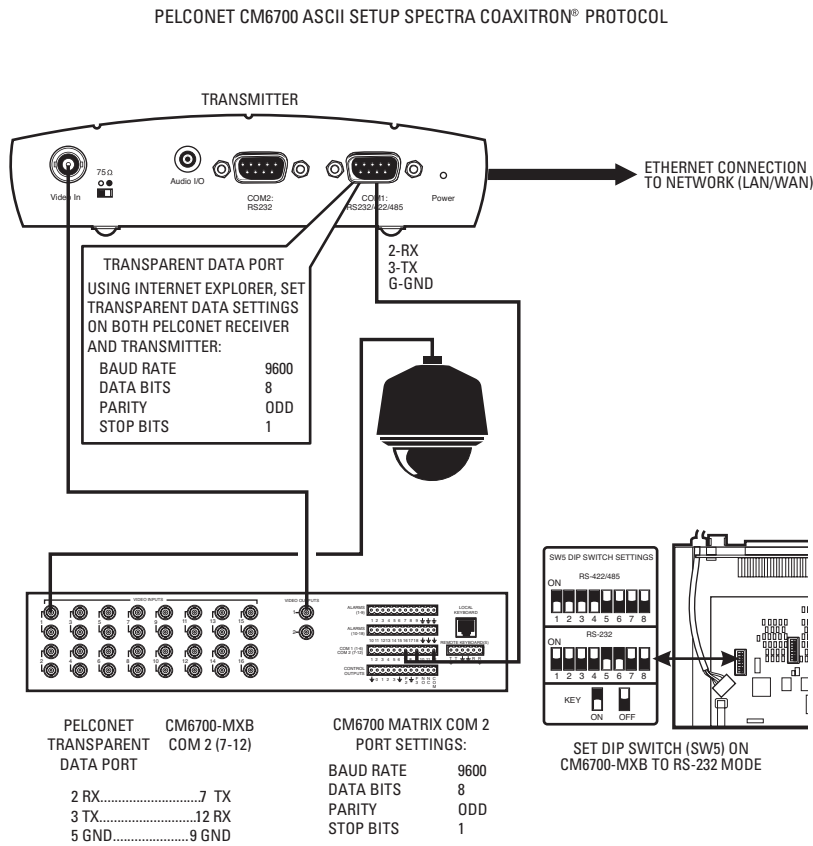

Figure 57. Using PelcoNet with CM6700 to Provide Remote Control

CONNECTING PELCONET TO A CM9760-DT FOR REMOTE BROWSER CONTROL

Refer to Figure 58. This configuration lets an operator view and control cameras on a PC using a web browser. (The operator's PC is not shown on the diagram.)

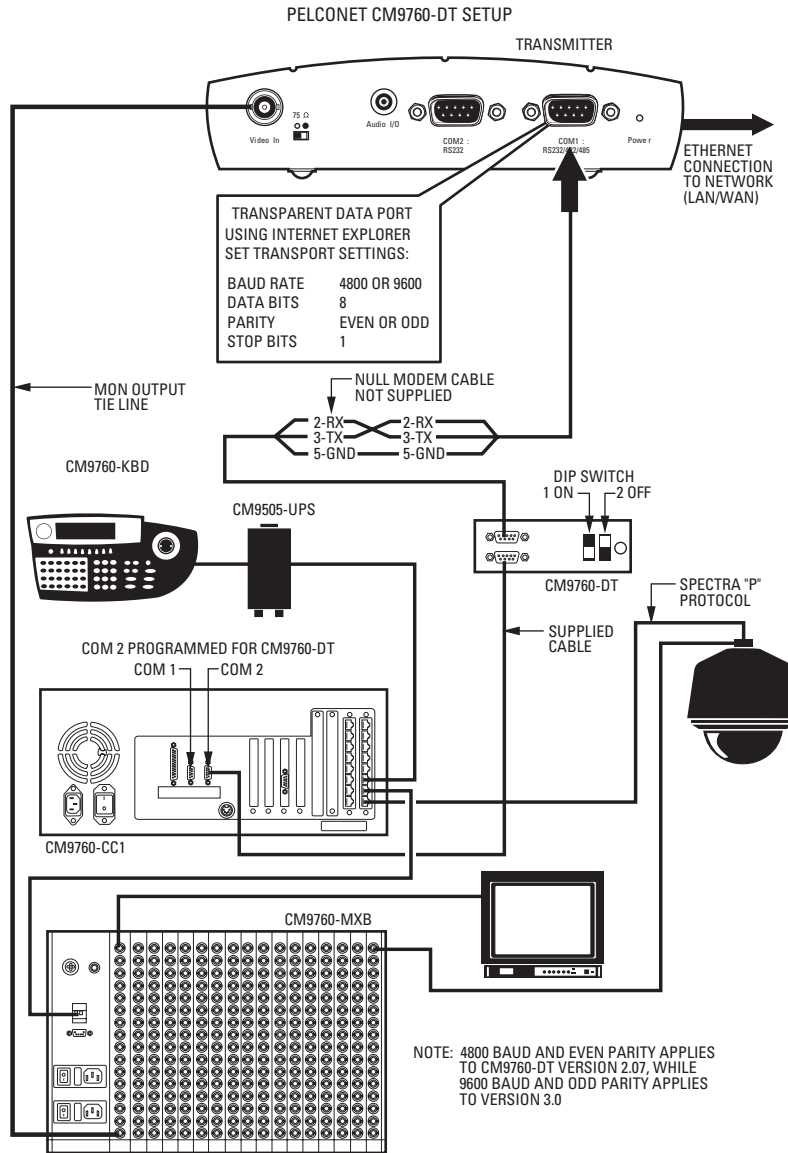

Figure 58. Using PelcoNet with CM9760-DT to Provide Remote Control of a 9760 Monitor Output

CONNECTING PELCONET TO CM9700 FOR REMOTE COMMUNICATION

Refer to Figure 50 and Figure 59 and Figure 60. These configurations let an operator remotely view and control cameras connected to the CM9700.

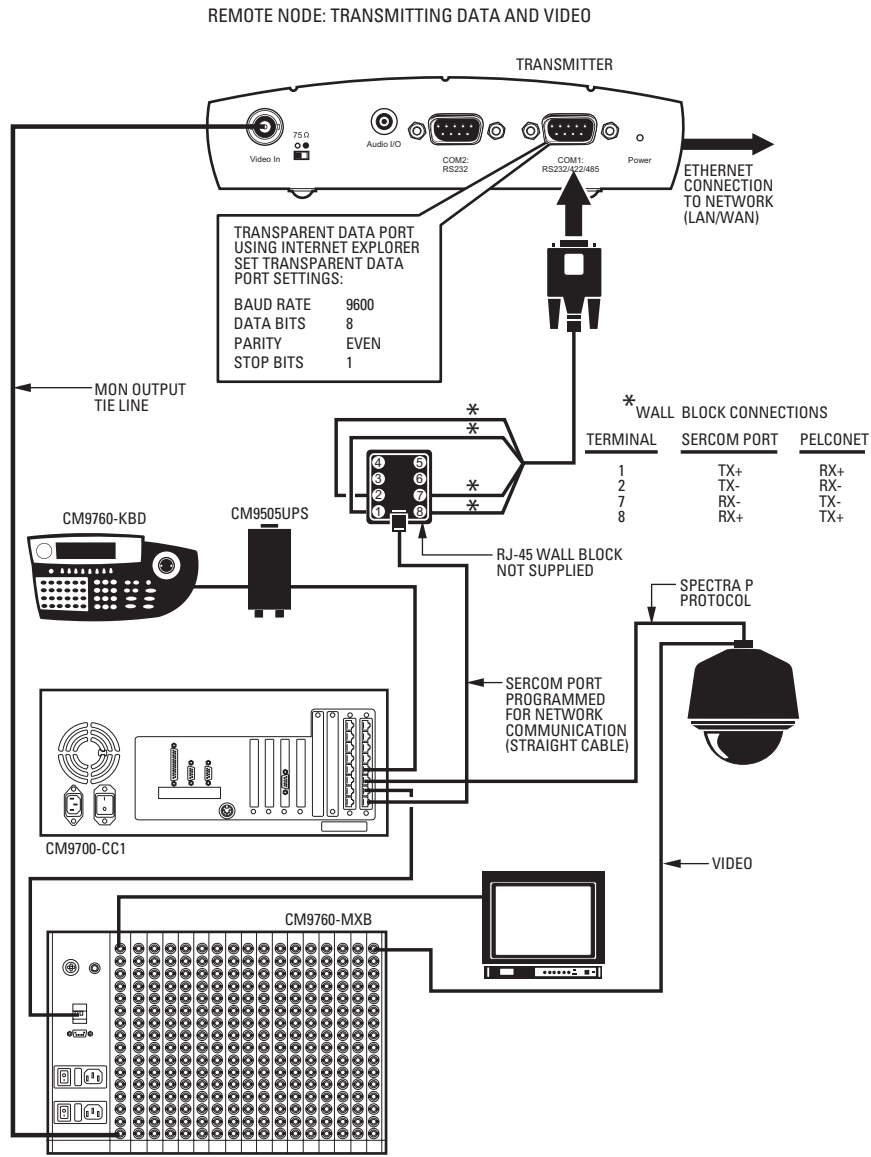

Figure 59. Using PelcoNet to Transmit Data and Video Between 9700 Nodes (9760 Shown)

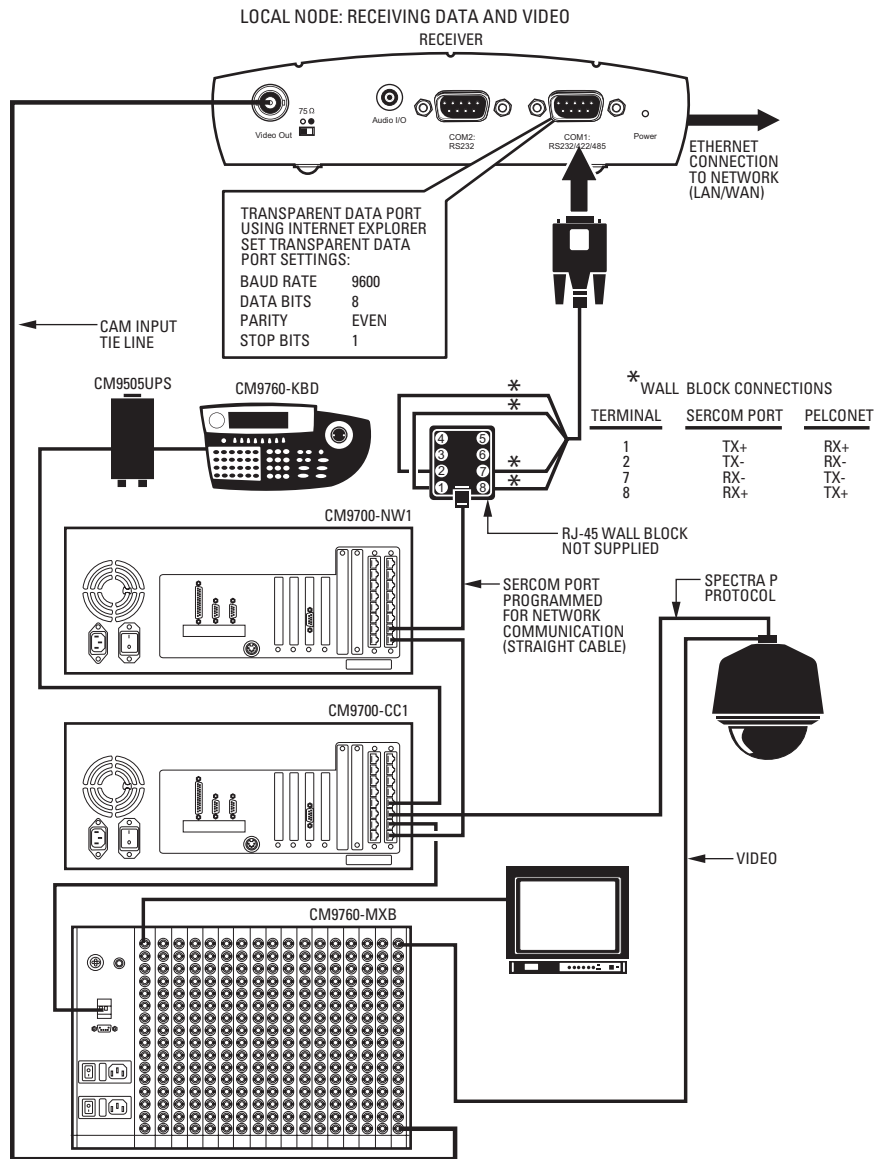

Figure 60. Using PelcoNet to Receive Data and Video Between 9700 Nodes (9760 Shown)

CONNECTING A PELCONET TRANSMITTER TO THE CM6800 ASCII PORT

Refer to the transmitter portion of Figure 63. This configuration lets an operator view and control cameras with a PC using a web browser. (The operator's PC is not shown on the diagram.) All settings are done in the CM6800 manager program or through a CM6800 menu. Note the following:

- Port 2 defaults to ASCII and RS-232.
- Ports 7 and 8 can be set to ASCII and RS-232 by using the CM6800 manager program (refer to Figure 63) or by using a CM6800 menu (refer to Figure 60).
- Pelco recommends using Port 2.

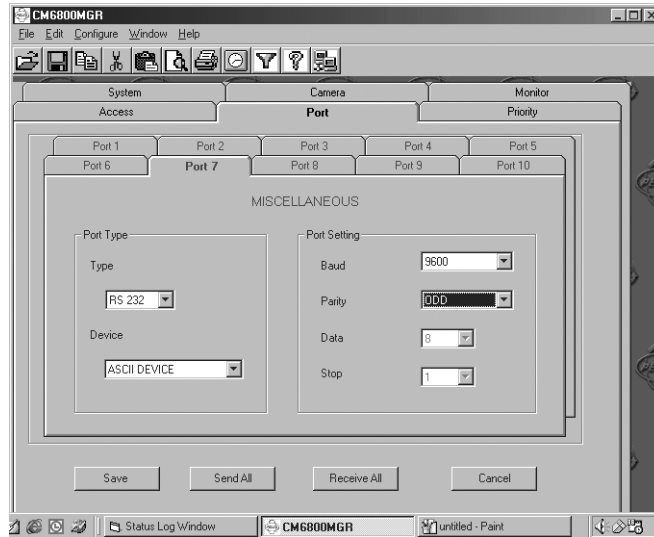

Figure 61. Manager Screen

```
SET SERIAL PORT 07
DEVICE:      ASCII
TYPE:        RS232
BAUD RATE:   9600
PARITY:      ODD
DATA BITS:   8
STOP BITS:   1
RETURN
```

Figure 62. Menu Screen

CONNECTING PELCONET TO A CM6800 AND KBD200A FOR REMOTE CONTROL

Refer to Figure 63. This configuration lets an operator view and control cameras with a remote KBD200A keyboard. All settings are done in the CM6800 manager program or through a CM6800 menu. Note the following:

- Port 2 defaults to ASCII and RS-232.
- Ports 7 and 8 can be set to ASCII and RS-232 by using the CM6800 manager program (refer to Figure 63) or by using a CM6800 menu (refer to Figure 60).
- Pelco recommends using Port 2.

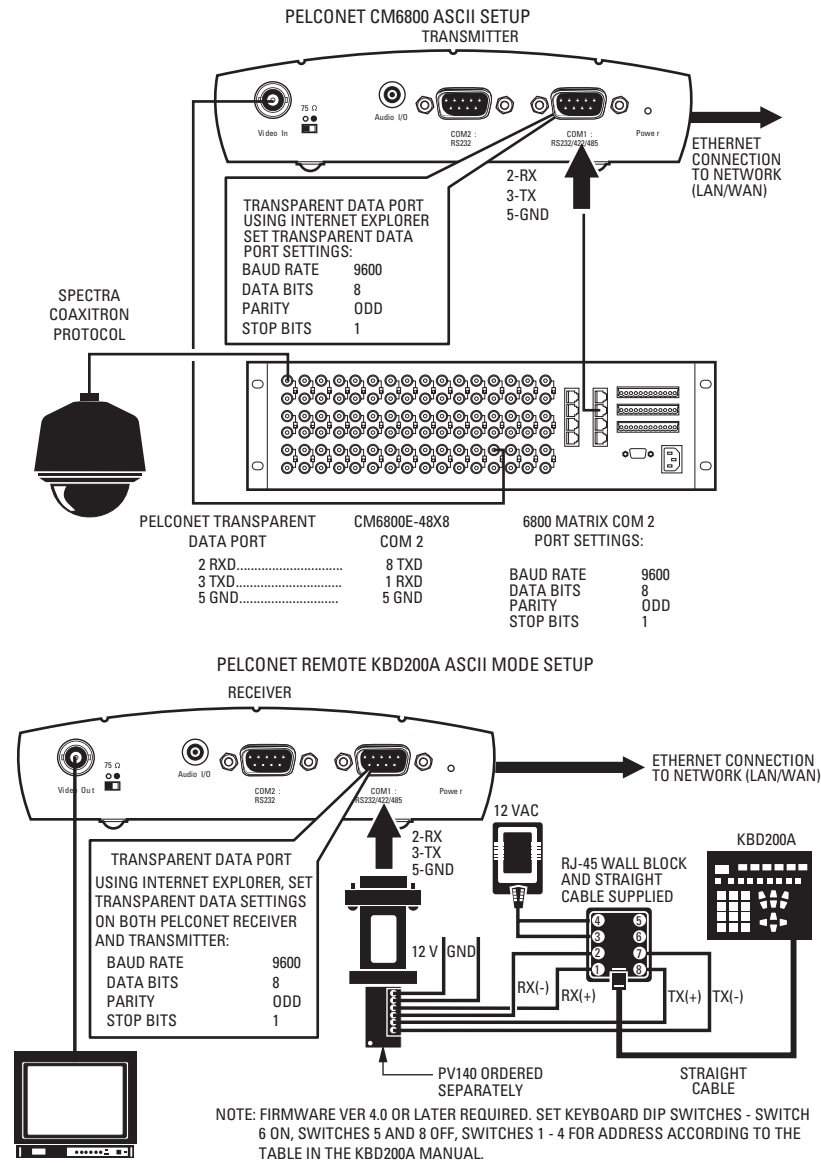

Figure 63. Using PelcoNet with CM6800 and KBD200A to Provide Remote Control

Appendix B — Frequently Asked Questions (FAQs)

1. What Pelco devices can I control from my computer with PelcoNet?

PelcoNet can control the following from Internet Explorer:

- Spectra and Esprit
- Genex multiplexer
- CM9760 matrix (requires CM9700 data translator)
- CM9740 matrix (requires CM9700 data translator)
- CM9502 matrix (through integrated ASCII port)
- CM8500 matrix (requires latest CM8500 data translator)
- CM6700 matrix (through integrated ASCII port, COM 2)
- CM6800 matrix

2. Can I view PelcoNet over the Internet?

Yes. You will need a static IP address and enough bandwidth to view live video. Pelco recommends a minimum of 250 Kbps for medium image quality. Also check with your ISP to verify the correct TCP and UDP ports are open through any routers or firewalls through which you will connect.

3. How many connections does PelcoNet support? Can more than one receiver connect to a transmitter at the same time?

Yes. PelcoNet can support up to 25 simultaneous connections. To do so, all hubs, switches, and routers must support multicasting (IGMP), and PelcoNet must be configured to use multicasting. If the network hardware does not support this, then the maximum number of simultaneous connections is five.

4. Can I enlarge the picture size in the browser?

Yes. You can select from two different image sizes in PelcoNet with the browser: 352 x 288 or 704 x 576.

5. What software does PelcoNet require?

PelcoNet works with Internet Explorer 6.0 or higher. An ActiveX plug-in and Microsoft Virtual Machine are also required for Internet Explorer to get live video. All software is included.

6. Can I control other manufacturers' equipment from the browser?

Not at this time.

7. Can I record video with PelcoNet?

Yes. PelcoNet can record video to the hard drive of the viewing PC or onto the NET350 itself using the CompactFlash interface. The video is recorded in MPEG-4 format, which allows playback through either the browser or the proprietary MPEG Viewer software included on the resource CD.

8. Everything is wired correctly but I do not have any control from the browser. What else could be wrong?

The transparent port settings should be set to match the equipment to which PelcoNet is connected.

Also, in Internet Explorer, the Microsoft Virtual Machine should be enabled. To do so: on the Tools menu, select **Internet Options**. Then select the **Advanced** tab. Locate the option **Microsoft VM**. Place a checkmark next to **Java Console Enabled** and **JIT compiler for virtual machine** enabled. Reboot your computer.

These options are required for the Java applets in PelcoNet to function properly.

9. Can I control the Genex multiplexer from the browser and have a local KBD4000?

Yes. You must have Genex version 4.1 or higher for Genex units manufactured before November 22, 2002 or version 1.12 or higher for units manufactured on or after that date. (The version numbering was restarted in 2002, which is why newer units have a smaller version number.) These versions let you connect a KBD4000 to the COM IN port, and PelcoNet to the COM OUT port. This gives you both local and remote control. Refer to *Connecting PelcoNet to the COM OUT RS-422 Port on a Genex Multiplexer* in *Appendix A* for detailed information.

10. **Can I control the Genex multiplexer server?**

Not at this time.

11. **Can I use DHCP (dynamically assigned IP address) with PelcoNet?**

No.

12. **What type of compression does PelcoNet NET350 use?**

PelcoNet uses the MPEG-4 industry standard for video teleconferencing over the Internet. It provides the most effective use of bandwidth with excellent video quality.

13. **I do not get live video in the browser but server push is working. What could be wrong?**

Verify that the ActiveX plug-in is installed and that your video is set to 16-bit color. Also check with your network administrator to verify that the TCP/IP ports PelcoNet uses are not being filtered and that you have enough bandwidth.

14. **How do I program PelcoNet with HyperTerminal?**

Using a null modem cable, connect a COM port on your PC to the COM 1 port on PelcoNet. Open HyperTerminal and set the port to use 19200, 8, N, 1, and No Flow Control. Type ?, and follow the help menu.

15. **How much bandwidth does PelcoNet use?**

PelcoNet's bandwidth is adjustable. You can set it from 9.6 kbps up to 5000 kbps. Pelco recommends a minimum of 250 Kbps for live video at medium image quality. Check with your network administrator for how much bandwidth to use.

16. **Can I use PelcoNet with a DSL or cable connection?**

Yes. You will need a static IP address from your provider. Also verify what kind of bandwidth you will get since it varies by location. Verify that your provider is not filtering the TCP/IP ports that PelcoNet uses.

17. **Is an RS-232 to RS-422/485 converter required for control with PelcoNet?**

No. The NET350's COM 1 port supports RS-232, RS-422, and RS-485.

18. **What TCP/IP ports should I use with PelcoNet?**

- If you will be using PelcoNet in a LAN environment, Pelco recommends all TCP/UDP ports above 1024 be opened. Also, if you will use a time server, TCP port 37 must be opened.
- If you will be using PelcoNet in a WAN environment, Pelco recommends changing the "Video/Audio transmission" setting to "TCP" in the Network Settings configuration page. This makes PelcoNet use port 80 and whatever source port the client computer chooses.

Index

A

Alarm indicator 39
Alarm input 25, 39
Alarm recording on 50
Alarm recording scheduler 48
Alarm recording tab 46
Alarm recording time 50
Audio settings configuration page 35
Auxiliaries (matrix) 59
Average n (frames) 39

B

Backing up a file onto a computer 67
Baud rate 42, 43, 44
Bistable 41
Box-to-box connection 27

C

Camera (Genex) 60
Camera (matrix) 58
Camera (name) 34
Camera name stamping 34
COM 1 Interface Setting 42
Com 1 interface settings page 42
Com 2 interface settings configuration page 43
CompactFlash 64
Configuration pages – alarm settings 37
Configuration pages – audio settings 35
Configuration pages – COM 1 interface settings 42
Configuration pages – COM 2 interface settings 43
Configuration pages - general settings 31
Configuration pages – general settings 31
Configuration pages – keyboard 44
Configuration pages – media recording settings 46
Configuration pages – network settings 45
Configuration pages – relay settings 41
Configuration pages – video settings 33
Configuration types 27
Configuration upload 33
Configuration using a terminal program 50
Configuration using a Web browser 27
Connect on alarm 40
Connecting a relay 26
Connecting audio 24
Connecting power 26
Connecting to a LAN 26
Connecting to various components 75
Connecting video 23

D

Data bits 42, 43, 44
Data terminals (connecting) 24
Datarate 34
Date format 32
Default IP address 45
Default IP addresses 55
Display alarm stamping 34
Displayed alarm message 34

E

Enable audio encoder 36
Enter partition settings! 46
Esprit control page 62

F

Frame skip ratio 34
Free on this partition 50
Front panel components 11

G

Gateway IP address 45
General settings configuration page 31
Genex control page 59
Genex protocol ID 42

H

Half-duplex mode 42
Hardware version 32
Home page 28

I

Idle state 41
Indicator buttons (live page) 55
Installation (hardware) 23
Interface mode 42
Intra frame distance 34
IP address 8

K

Keyboard settings configuration page 44

L

LEDs definition 69
Live video 56
Live video auto-connect 40
Live video control 57
Live video receiver IP address 40
Local sensitivity 39

M

Macros (matrix) 59
Matrix control page 58
Media Playback Screen 66
Media recording settings configuration pages 46
Menu tree 29
Microsoft Virtual Machine enabling 56
Minimum PC requirements 9
Monitor (Genex) 60
Monitor (matrix) 58
Monostable 41
Motion detection 39
Motion tracking 39
MPEG-4 encoder 1/2 button 34
Multicast audio port MPEG-4 46
Multicast group IP address 45
Multicast packet TTL 46

Multicast streaming 45
Multicast video port encoder 1/2 46
Multicasting protocols 10

N

Name of encoder 34
NET-Manager 28
Network administrator instructions 9
Network settings configuration page 45
Number of alarms 50
Number of video receiver address 40

O

Object min size (nxn blocks) 39
Operating mode 41

P

Parameter preset 34
Parity 44
Parity check 42, 43
Partition name 50
Partition number 50
Partition selection 46
Partition total size 50
Password 32
Password confirm 32
Password level 32
Password settings 32
Patterns (Esprit) 62
Patterns (Genex) 60
Patterns (matrix) 59
Patterns (Spectra) 61
PC recording/viewing 63
Peripherals (connecting) 25
Pin assignments 24
Preset parameter name 34
Presets (Esprit) 62
Presets (Genex) 60
Presets (matrix) 59
Presets (Spectra) 61
Programming menus (Esprit) 62
Programming menus (Spectra) 61
Properties button 46

R

Rear panel components 11
Recording active 46
Recording the video display onto CompactFlash 64
Recording the video display onto the PC 64
Relay follows 41
Relay name 41
Relay settings configuration page 41
Remaining for recording 50
Remote receiver password 40
Reset this parameter preset 34
Resetting PelcoNet 68

S

Select area button 39
Sequence (Genex) 60
Serial interface 10

Serial port function 42, 43
Server push 56
Server push display 57
Server push page 55
Snapshots (record from video) 64
Snapshots (recording from file) 67
Snapshots (viewing) 64
Software upload 33, 68
Software version 10, 32
Specifications 71
Spectra control page 60
Spectra/Esprit protocol ID 42
Stop bits 42, 43, 44
Stop/Start buttons 46
Storing Files 63
Subnet mask 45

T

Terminal program receiver menu structure 53
Terminal program transmitter menu structure 52
Time recording scheduler 48
Time recording tab 46
Time server IP address 32
Time stamping 34
Time zone 32
Total used size from partition 50
Tracker 39
Trigger relay 41
Troubleshooting 69
Type of recording 50

U

Unified picture detection 39
Unit Date 32
Unit ID 32
Unit IP address 45
Unit name 32
Unit time 32
Upload progress 33
Used alarmtracks from partition 50
Used filetracks from partition 50

V

Video loss alarm 39
Video motion alarm 39
Video on a Web browser 56
Video page 55
Video page indicators 55
Video recording 50
Video resolution 34
Video settings configuration page 33
Video via transmitter-to-receiver 12
Video/audio transmission 45
Viewing a file 66
Viewing the video display 65

W

Web browser 9
Web browser control pages 57

PRODUCT WARRANTY AND RETURN INFORMATION

WARRANTY

Pelco will repair or replace, without charge, any merchandise proved defective in material or workmanship **for a period of one year** after the date of shipment.

Exceptions to this warranty are as noted below:

- Five years on FT/FR8000 Series fiber optic products.
- Three years on Genex® Series products (multiplexers, server, and keyboard).
- Three years on Camclosure® and fixed camera models, except the CC3701H-2, CC3701H-2X, CC3751H-2, CC3651H-2X, MC3651H-2, and CC3651H-2X camera models, which have a five-year warranty.
- Two years on standard motorized or fixed focal length lenses.
- Two years on Legacy®, CM6700/CM6800/CM9700 Series matrix, and DF5/DF8 Series fixed dome products.
- Two years on Spectra®, Esprit®, ExSite™, and PS20 Scanners, including when used in continuous motion applications.
- Two years on Esprit® and WW5700 Series window wiper (excluding wiper blades).
- Eighteen months on DX Series digital video recorders, NVR300 Series network video recorders, and Endura™ Series distributed network-based video products.
- One year (except video heads) on video cassette recorders (VCRs). Video heads will be covered for a period of six months.
- Six months on all pan and tilts, scanners or preset lenses used in continuous motion applications (that is, preset scan, tour and auto scan modes).

Pelco will warrant all replacement parts and repairs for 90 days from the date of Pelco shipment. All goods requiring warranty repair shall be sent freight prepaid to Pelco, Clovis, California. Repairs made necessary by reason of misuse, alteration, normal wear, or accident are not covered under this warranty.

Pelco assumes no risk and shall be subject to no liability for damages or loss resulting from the specific use or application made of the Products. Pelco's liability for any claim, whether based on breach of contract, negligence, infringement of any rights of any party or product liability, relating to the Products shall not exceed the price paid by the Dealer to Pelco for such Products. In no event will Pelco be liable for any special, incidental or consequential damages (including loss of use, loss of profit and claims of third parties) however caused, whether by the negligence of Pelco or otherwise.

The above warranty provides the Dealer with specific legal rights. The Dealer may also have additional rights, which are subject to variation from state to state.

If a warranty repair is required, the Dealer must contact Pelco at (800) 289-9100 or (559) 292-1981 to obtain a Repair Authorization number (RA), and provide the following information:

1. Model and serial number
2. Date of shipment, P.O. number, Sales Order number, or Pelco invoice number
3. Details of the defect or problem

If there is a dispute regarding the warranty of a product which does not fall under the warranty conditions stated above, please include a written explanation with the product when returned.

Method of return shipment shall be the same or equal to the method by which the item was received by Pelco.

RETURNS

In order to expedite parts returned to the factory for repair or credit, please call the factory at (800) 289-9100 or (559) 292-1981 to obtain an authorization number (CA number if returned for credit, and RA number if returned for repair).

All merchandise returned for credit may be subject to a 20% restocking and refurbishing charge.

Goods returned for repair or credit should be clearly identified with the assigned CA or RA number and freight should be prepaid. Ship to the appropriate address below.

If you are located within the continental U.S., Alaska, Hawaii or Puerto Rico, send goods to:

Service Department
Pelco
3500 Pelco Way
Clovis, CA 93612-5699

If you are located outside the continental U.S., Alaska, Hawaii or Puerto Rico and are instructed to return goods to the USA, you may do one of the following:

If the goods are to be sent by a COURIER SERVICE, send the goods to:

Pelco
3500 Pelco Way
Clovis, CA 93612-5699 USA

If the goods are to be sent by a FREIGHT FORWARDER, send the goods to:

Pelco c/o Expeditors
473 Eccles Avenue
South San Francisco, CA 94080 USA
Phone: 650-737-1700
Fax: 650-737-0933

REVISION HISTORY

Manual #	Date	Comments
C2907M	10/03	Original version.
C2907M-A	12/03	Changed parity from "odd" to "none" in text and on Figure 56.
C2907M-B	3/04	Added information on the NET350R Video Decoder Settings page. Revised the <i>Troubleshooting</i> section. Replaced the KBD4000 with a CM9760-KBD in Figure 50. Revised the definition for the "Time server IP address" field to remove "NTP." Added audio information to the <i>Specification</i> section.
C2907M-C	12/04	Added information, application, and connection drawing about the Local COM Interface – Keyboard feature. Included information on the Video Watermarking MPG-4, Video Quality Settings, and Field Mode fields that were added to the Video Configuration page. Updated the menu tree, the Setup page, and the Device Control page to reflect these changes. Corrected Figure 56 (now Figure 60) in which a CM9760-NW1 was incorrectly labeled a CM9760-CC1. Added NTSC pixel resolution to the <i>Specifications</i> section.
C2907M-D	4/05	Revised Figure 16, corrected Figure 24, and added a new Figure 26. Also corrected the old Figure 26 (which is now the new Figure 27). Added "4CIF" and "custom" to the description of the Video Resolution field. Corrected NTSC video image size in the Specifications section. Made numerous formatting changes.

Pelco, the Pelco logo, Spectra, Esprit, Genex, Camclosure, Legacy, and Coaxitron are registered trademarks of Pelco.

PelcoNet is a trademark of Pelco.

Microsoft, Windows, DirectX, and ActiveX are registered trademarks of Microsoft Corporation in the United States and/or other countries.

ATI RADEON is a trademark of ATI Technologies Inc.

Pentium 4 is a registered trademark of Intel Corporation.

Parhelia is a trademark of Matrox Technologies Inc.

Compact Flash is a registered trademark of SanDisk Corporation.

NVIDIA is a registered trademark of NVIDIA Corporation.

© Copyright 2005, Pelco. All rights reserved.



Worldwide Headquarters
3500 Pelco Way
Clovis, California 93612 USA

USA & Canada
Tel: 800/289-9100
Fax: 800/289-9150

International
Tel: 1-559/292-1981
Fax: 1-559/348-1120

www.pelco.com

ISO9001

United States | Canada | United Kingdom | The Netherlands | Singapore | Spain | Scandinavia | France | Middle East